

MP FILTRI in the world



NEW FMP 039



NEW FMP 039

MP FILTRI in the world



WHAT CHANGES

New FMP 039

Head

Aluminum die casting Anodized

Housing

Hot forming Anodized

Benefits new version

- More accurate surface finish
- Increased mechanical strength
- New head design, geometric modification of the internal passages
- Reduction of pressure drop - flow increase

Old FMP 038

Aluminum gravity Anodized

Aluminum gravity Anodized

Δp Body FMP038 Vs. new FMP 039
oil density 0.86

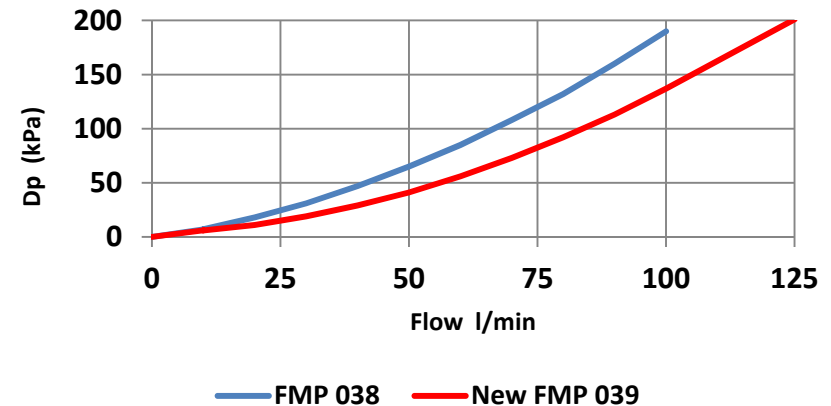

NEW FMP 039

MP FILTRI in the world



WHAT CHANGES

New position of the by-pass valve

Old FMP 038

Valve inserted optionally in one of the two side connections

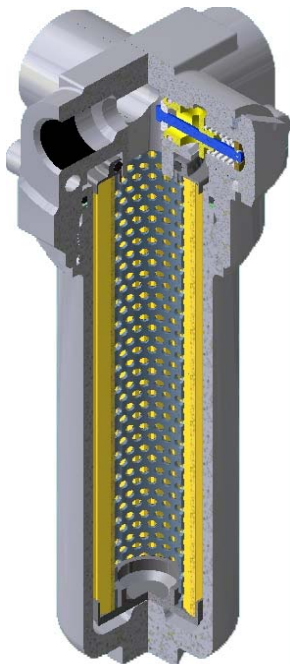

New FMP 039

By-pass valve mounted in line between the connections IN / OUT

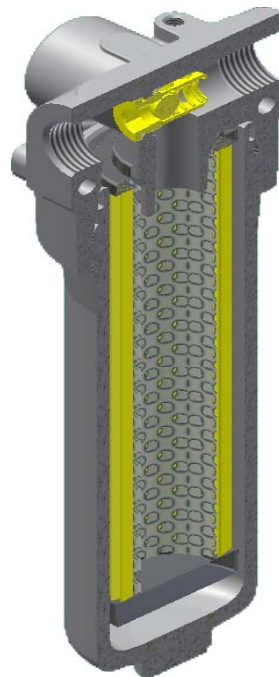

Benefits new version

New by-pass valve

Better performance, lower pressure drop

Δp By-pass FMP 38 Vs. New FMP 039
Oil viscosity 30 cst.

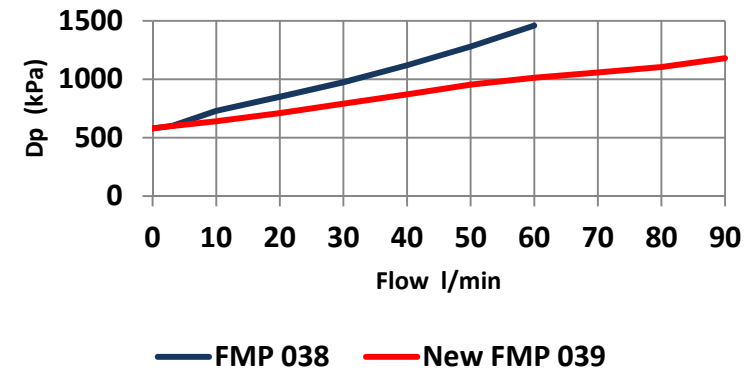

NEW FMP 039

WHAT CHANGES

MP FILTRI in the world



Dimensions

New FMP 039

Old FMP 038

No variation in external dimension.

New FMP FMP 039 perfectly interchangeable at the old FMP 038.

Benefits new version

In the new version, we added two threaded holes on the head for the possibility of clamping on a horizontal bracket

NEW FMP 039

MP FILTRI in the world



WHAT CHANGES

Mounting Installation

Thanks to the new position of the valve by-pass, the new FMP 039 allows a greater flexibility in mounting.

Benefits new version

5 Are the possible options for the IN/OUT pipes connection

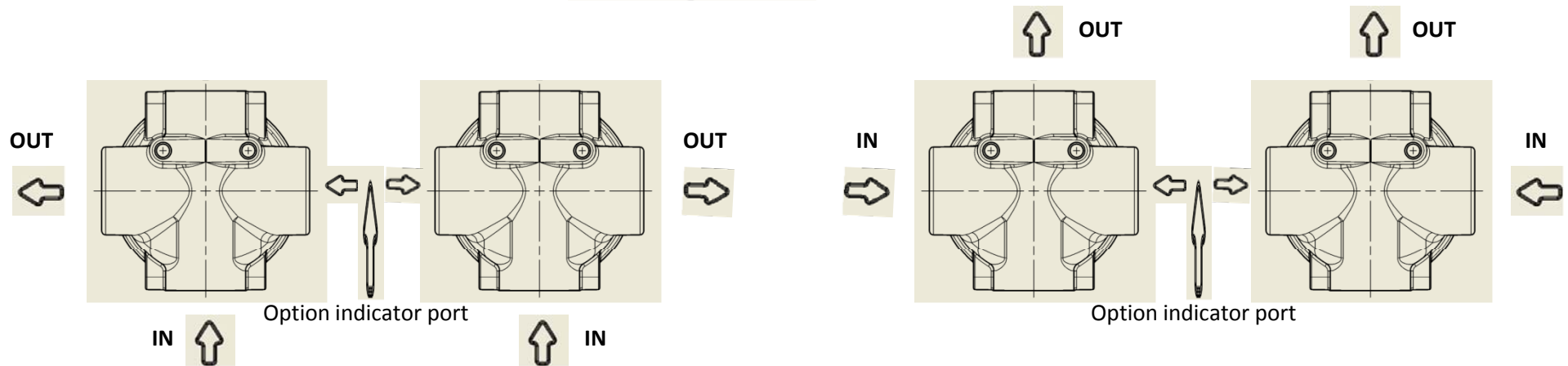
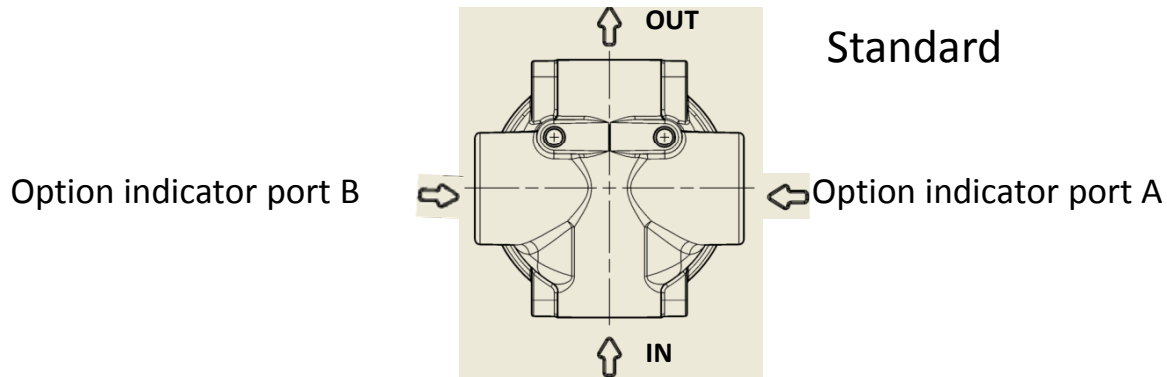

NEW FMP 039

MP FILTRI in the world



WHAT CHANGES

Ordering code, filter elements

Old Code filter element for :

FMP038

No dimensional change

NEW Code filter element for :

FMP039

HP 037 1...

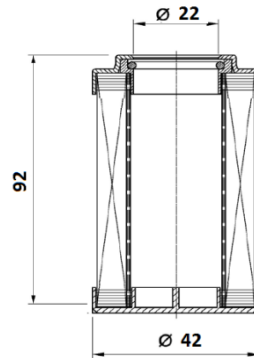

HP 037 5 ...

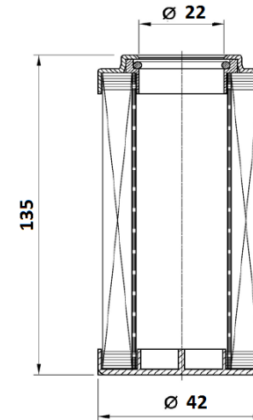

HP 037 2 ...

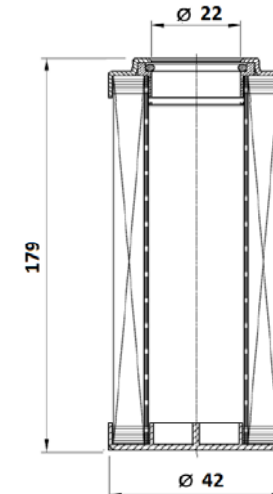

HP 039 2...

HP 039 3 ...

HP 039 4 ...

Benefits new version

ID alignment between the filter code and filter element

NEW FMP 039

MP FILTRI in the world



Headquarter:

MP FILTRI S.p.A. ITALY
sales@mpfiltri.com



GREAT BRITAIN
MP FILTRI U.K. Ltd.
sales@mpfiltri.co.uk

GERMANY
MP FILTRI D GmbH
service@mpfiltri.de

FRANCE
MP FILTRI FRANCE Sas
sales@mpfiltrifrance.com

USA
MP FILTRI USA Inc.
sales@mpfiltriusa.com

CANADA
MP FILTRI CANADA Inc.
Mail@mpfiltricanada.com

RUSSIAN FEDERATION
MP FILTRI RUSSIA
mpfiltrirussia@yahoo.com

CHINA
MP FILTRI (Shanghai) Co. Ltd.
sales@mpfiltrishanghai.com

INDIA & UAE
MP FILTRI INDIA & UAE
s.mishra@mpfiltri.com