



# Operators Guide ICM 4.0

## In-line Contamination Monitor with Integrated WiFi Technology





# PRODUCT OVERVIEW

## ICM 4.0 - In-line Contamination Monitor with Integrated WiFi Technology

The ICM 4.0 automatically measures and displays particulate contamination, moisture and temperature levels in various hydraulic fluids. It is designed specifically to be mounted directly to systems, where ongoing measurement or analysis is required, and where space and costs are limited.

### Features & Benefits

- Integrated WiFi
- Mobile APP 8 channel contamination measurement & display
- Measures and displays the following international standard formats:  
ISO 4406, NAS 1638, AS 4059E
- Moisture and temperature sensing (fluid dependent)
- Data logging and 4000 test result memory
- Manual, automatic and remote control flexibility
- Multicolour indicators via LCD (K versions) and LED with output alarm signals as standard
- Robust die cast aluminium construction
- LPA View software (included)
- Pressure max. 420 bar
- Environmental protection IP65/67 versatile
- Secondary connector to allow the simultaneous control/download of results during operation
- A variety of communication protocols as standard, RS485, Modbus, CANbus, 4-20mA analogue output
- Live real-time monitoring
- Atex zone II options available (ICM 4.0 MK1 version)
- Free LPA View software Windows based



## Product Presentation

The ICM 4.0 measures and quantifies the numbers of solid contaminants in Hydraulic, Lubrication and Transmission applications. The ICM 4.0-M is designed to be an accurate instrument for permanently installed applications utilising mineral oil as the operating fluid. Other fluid media versions are available for offshore [N] and aerospace phosphate ester [S] applications.

The unit can operate using any of the international standard formats ISO 4406, NAS 1638, AS 4059E/F and ISO 11218.

The ICM 4.0 incorporates a machine connector for power and PLC connection, capable of RS485, CANbus or 4-20mA signaling. A separate connector is also provided for simultaneous computer remote monitoring or settings access using RS485 or a USB:RS485 interface.

The integrated data logger records up to 4000 test results internally, for use where a computer cannot be permanently connected.

Simple switched inputs and alarm outputs are provided as alternative means of controlling the testing and signaling the results. The “full colour” front panel led provides a basic indication of the cleanliness level.

The instrument uses the light extinction principle whereby a specially collimated precision LED light source shines through the fluid and lands on a photodiode. When a particle passes through the beam it reduces the amount of light received by the diode, and from this change in condition, the size of the particle can be deduced.

### Benefits

- Live real time monitoring
- Manual, automatic and remote control flexibility
- Moisture and temperature sensing
- Multicolour LCD and LED for clear visual indication of any faults and alarms

## Product features

### Moisture Sensor

ICM 4.0-W models measure water content using a capacitive RH (relative humidity) sensor. The result is expressed as percentage saturation. 100% RH corresponds to the point at which free water exists in the fluid, i.e. the fluid is no longer able to hold the water in a dissolved solution. This is also normally the point at which damage occurs in a hydraulic system, so is an ideal measurement scale that is independent of the fluid characteristics.

The water saturation point (100% RH) is temperature dependent, so the temperature is measured at the same time. This enables results to be compared meaningfully.

The temperature measured is that of the fluid passing through the unit. Note this may differ from that of the hydraulic system, depending on flow rate, pipe length and ambient temperature. It is not intended to be an accurate indication of system temperature, but to provide a reference for the RH measurement. Nevertheless experience has shown the temperature measured is within a few degrees of that of the hydraulic system, in most applications.

# PRODUCT OVERVIEW

## Data Logger

The ICM 4.0 includes a built-in data logger, which adds the facility to log and timestamp test results locally within an internal memory, even when not connected to a computer.

- Test logging is determined by the log settings (see section 5.3.3.7).
- Each log entry is time-stamped and contains the ICM 4.0 serial number, so that it can be identified later.
- The ICM 4.0 memory has space for around 4000 log entries. When full, the oldest log entry is overwritten.

See section 5.3.2 for details of how to download the test log via bespoke windows based software.

## Status LED

All ICM 4.0 versions have a multicolour indicator on the front panel, which is used to indicate the status or alarm state. ICM 4.0-K versions also have a screen that changes colour. The alarm thresholds can be set from LPA-View via the serial interface.

## Screen and multicolor indicators

- Green indicates that the test result passed, i.e. none of the alarm thresholds were exceeded
- Yellow indicates that the lower cleanliness limit was exceeded, but not the upper one
- Red indicates that the upper cleanliness limit was exceeded
- Blue indicates that the upper water content limit was exceeded
- Red/Blue Alternating indicates both cleanliness and water content upper limits exceeded
- Violet indicates that the upper temperature limit was exceeded



Left facing view

Right facing view



Top view

Bottom view

## Disclaimer

Aspart of our policy of continual improvement, MP Filtri reserves the right to alter the specification without prior notification.



# DECLARATION OF CONFORMITY

## EC Declaration of Conformity

The products included in this Declaration are all variants of the following:

- Integrated WiFi
- With or without a moisture sensor
- Compatible with mineral oil/ synthetic fluids, offshore fluids, phosphate esters (inc. aerospace versions)
- With or without a keypad/ display
- With relay outputs
- With Modbus, CANbus and 4-20mA outputs

For part codes see the Designation & Ordering Code (section 4.8 on page 20).

Product Manufacturer:

MP Filtri UK  
Bourton Industrial Estate  
Bourton on the Water  
Cheltenham  
Gloucestershire  
GL54 2HQ  
01451 822522  
sales@mpfiltri.co.uk

The products described are in conformity with the following directives:

2014/30/EU Electromagnetic Conformity

Certification Testing that has been carried out is in accordance with:

- DEF STAN 00-35 Part 3 issue 4 Environmental Test Methods
- BS EN 60068 range of standards covering environmental conditions
- BS EN 60529: 1992 + A2:2013 Degrees of Protection provided by enclosures (IP Code)
- BS EN 62262:2002 Degrees of Protection Provided for Electrical Equipment against External Mechanical Impacts (IK Code)
- BS EN 60721-3-4: 1995 Part 3: Classification of Groups of Environmental Parameters and their severities, Section 3.4

Date: July 2020

Signed  
Phil Keep (Managing Director) on behalf of MP Filtri UK Ltd



	Page
<b>Product overview</b>	<b>1</b>
EC Declaration of Conformity	5
Table of Contents	6
What this guide is for	8
<b>1 General warnings and information for the Operator</b>	<b>10</b>
1.1 General safety warnings	10
1.2 Operator position and dangerous areas	12
1.3 Dangers and Hazards that cannot be eliminated	12
1.4 Personal Protective Equipment	12
<b>2 Transportation and Storage</b>	<b>15</b>
2.1 Transportation and Handling Conditions	15
2.2 Storage	15
<b>3 Warranty, Limitations and Disclaimers</b>	<b>16</b>
<b>4 Technical Specification</b>	<b>18</b>
4.1 Performance	18
4.2 Electrical Interface	18
4.3 Physical Attributes	19
4.4 Fluid Characteristics	19
4.5 Environment	19
4.6 Wetted Parts List	19
4.7 Dimensions	20
4.8 Designation & Ordering code	20
<b>5 Product Installation and General Operation</b>	<b>21</b>
5.1 Installation	21
5.1.1 Physical Procedure	21
5.1.2 Electrical Interface	22
5.1.3 Hydraulic Connection	28
5.2 General Operation	31
5.2.1 Physical Checks	31
5.2.2 Front Panel Operation	31
5.2.3 ICM 4.0 removal and Product Maintenance	33
5.3 ICM 4.0 Control	34
5.3.1 Computer Connection	34
5.3.2 PC Software Operation	35
5.3.3 Settings	36
5.4 Standard Communication Protocols	45
5.4.1 Modbus	45
5.4.2 CANbus	49
5.4.3 Analogue 4-20mA Modes	52
5.5 Disposal	55



# TABLE OF CONTENTS

	Page
<b>6 WiFi Installation</b>	<b>56</b>
6.1 Guide to installing the WFXI Wifi extender	56
6.2 Connecting to Wifi (ICM 2.0 and ICM 4.0)	57
6.3 Communication Platforms	58
6.3.1 MP Filtri Connect Status	59
6.3.2 Webpage monitoring	60
6.3.3 LPA-View Software	61
6.3.4 MP Filtri Connect Programs	61
6.3.4.1 MP Filtri Connect Console	61
6.3.4.2 MP Filtri Connect Status	62
6.3.4.3 Mobile MP Filtri Connect App	63
6.4 Discover button	64
6.4.1 Connect page	64
6.4.2 Option page	64
6.5 WiFi Router	64
6.5.1 Router Initial Setup Procedure	64
<b>7 Related Products</b>	<b>66</b>
7.1 ICMRDU 2.0	66
7.2 ICMUSBI	67
7.3 ICMFC	67
7.4 Spares	67
<b>8 Troubleshooting / FAQ</b>	<b>68</b>
8.1 Misuse of Product	68
8.2 Fault Finding	68
8.2.1 LED Flashing / Fault Codes	68
8.2.2 Test Status	69
8.2.3 Other Faults	69
8.3 Test Duration	70
<b>9 Reference</b>	<b>72</b>
9.1 Further Modbus Information	72
9.1.1 Modbus Registers	72
9.1.2 Implementing Modbus	77
9.2 Further CANbus information	78
9.2.1 Example Walkthrough	78
9.2.2 Messages	82
9.3 Hydraulic System Target Cleanliness Levels	86
9.4 Clean Working Practices	87
<b>10 Service and Recalibration</b>	<b>89</b>
<b>11 Fault Diagnosis</b>	<b>90</b>
11.1 Diagnosing suspect ICM 4.0 readings	90

## What this guide is for

This guide will take you through the installation and instructions for making the most out of your ICM 4.0. It contains detailed information to enable you to master the full functionality of the device, as well as key information on safety, warranty, maintenance and accessories.

At MP Filtri we are committed to customer service and hope this manual will help you to fully master the ICM 4.0.

### Disclaimer

As a policy of continual improvement, MP Filtri reserves the right to alter the specification without prior notice.

# OPERATOR'S GUIDE

# 1 General warnings and information for the Operator

## 1.1 General Safety Warnings

Do not operate, maintain or carry out any procedure before reading this manual. Any individual operating the unit shall wear the following Personal Protective Equipment:

- Protective eyewear
- Safety shoes
- Gloves
- Overalls (or other suitable protective clothing)

Before carrying out any machine installation procedures and/or before use, one should scrupulously follow the instructions listed in this manual. Moreover, it is necessary to comply with the current regulations related to occupational accident prevention and safety in the workplace.

Notices aimed at the prevention of health hazards for personnel operating the machine are highlighted in this document with signs having the following meaning:

It relates to important information concerning the product, its use or part of this documentation to which special attention must be paid



NOTE

It means that failure to comply with the relevant safety regulations may result in mild injury or property damage.



CAUTION

It means that failure to comply with the relevant safety regulations may result in death, serious injury or serious property damage.



DANGER

Failure to comply with the relevant safety regulations may result in death, serious injury or serious property damage.

# GENERAL WARNINGS

To allow rapid identification of the employees who must read this manual, definitions have been used with the following meaning:

OPERATOR	This is any individual whose task is to use the machine for production purposes. The operator is aware of all the measures taken by the machine manufacturer in order to eliminate any source of injury risk in the workplace and takes into account the operational constraints.
PERSONNEL INVOLVED IN SLINGING AND HOISTING OPERATIONS	This is any individual whose task is to handle the machine or parts of it. Personnel involved in slinging and hoisting operations are aware of the issues regarding the safe transfer of machinery or parts of it and, therefore, uses appropriate lifting equipment, following the instructions provided by the product manufacturer.
MACHINE SETTER	This is any individual whose task is to set up the machine for its operation. The machine setter is aware of the measures taken to eliminate all sources of injury risks in the workplace and takes into account the operational constraints. The machine setter takes all the appropriate precautions in order to operate in utmost safety conditions.
MAINTENANCE TECHNICIAN	This is any individual whose task is to carry out maintenance activities on the machine. The maintenance technician is aware of the possible danger situations that may arise and takes the appropriate precautions in order to eliminate the risks of accidents in the workplace.
ELECTRICIAN	This is any individual whose task is to carry out maintenance activities on the electrical wiring of the machine. The electrician is aware of the possible danger situations that may arise and takes the appropriate precautions in order to eliminate the risks of accidents in the workplace.

## 1.2 Operator Position and Dangerous Areas

No operator is required for operating the unit. However, the following areas are to be considered dangerous: hydraulic hoses /unit may become hot during use.

The unit shall be taken out of service and/or dismantled in accordance with the current regulations in force in the country where the machinery is installed



NOTE

The machinery is not suitable for outdoor use and all the electrical devices have a protection class starting from IP 55 upwards.



CAUTION

## 1.3 Dangers and Hazards that cannot be eliminated

- Burn risk because of high temperatures
- Accidental oil leaks with consequent risk of slipping
- Hose breakage and resulting lubricant loss
- With oil temperatures exceeding 40/45 °C, it is vital to be extremely careful when handling the hoses and when moving the unit. Avoid direct contact with hot oil and with the filter body.

ALL EQUIPMENT SHOULD BE ALLOWED TO COOL PRIOR TO HANDLING, AFTER IT HAS BEEN IN USE

## 1.4 Personal Protective Equipment

When operating the unit, personnel must be wearing safety shoes, gloves and goggles. In general, the PPEs to be used according to the activities on the machinery are listed in the following table:

ACTIVITY	PPE
Ordinary operation	Shoes, gloves, goggles, overall
Planned maintenance	Shoes, gloves, goggles, overall



# GENERAL WARNINGS





# TRANSPORT / STORAGE

## 2 Transportation and Storage

### 2.1 Transportation and handling Conditions

The unit is shipped in a cardboard box, encased in polyurethane foam.

The packed weight of the ICM 4.0 and accessories is 2.5 kg.

### 2.2 Storage

The unit should be stored in a suitable location away from the production area when not in use. The unit should be stored with the caps provided on the ports. This location should not impede any other production or personnel.

## 3 Warranty, Limitations and Disclaimers

MP Filtri warrants that the products that it manufactures and sells will be free from defects in material, workmanship & performance for a period of 12 months from the date of shipment.

### Hardware/Firmware

Should the hardware prove defective during the warranty period, MP Filtri, at its discretion, will either repair the defective product or replace it with an equivalent product in exchange for the defective unit without charge for parts, labour, carriage and insurance.

### Software

MP Filtri warrants that software will operate substantially in accordance with its functional specification for 12 months from date of shipment provided that the integrity of the operating environment has not been compromised through misuse, inappropriate handling, abnormal operating conditions, neglect or damage (unintentional or otherwise) or the introduction of third party product (software or hardware) that in any way conflicts with the MP Filtri product.

### Eligibility

This warranty extends to the original purchaser only or to the end-user client of a MP Filtri authorised affiliate.

### How to obtain service?

To obtain service under the terms of this warranty, the customer is required to notify MP Filtri before the expiration of the warranty period and to return the item in accordance with MP Filtri product return policy. Any product returned for warranty repair must be accompanied by a full fault report specifying the symptoms and the conditions under which the fault occurs. Should MP Filtri incur additional cost as a result of a failure to complete the appropriate paperwork, an administrative charge may be levied.

### Exclusions

This warranty shall not apply to any defect, failure or damage caused by improper use or improper or inadequate care. MP Filtri shall not be obligated to provide service under this warranty if:

- a) Damage has been caused by a failure to make a full and proper inspection of the product (as described by the documentation enclosed with the product at the time of shipment) on initial receipt of the product following shipment;
- b) Damage has been caused by the attempts of individuals, other than MP Filtri staff to repair or service the product;
- c) Damage has been caused by the improper use or a connection with incompatible equipment or product including software applications.

### Charges

Under cover of this warranty, MP Filtri will pay the carriage and insurance charges for the shipment of defective product back to site of manufacture and for its return to the client's original site of despatch except when:

- a) MP Filtri product return policy has not been followed.
- b) Product failure is caused by any of the exclusions described above, when the customer will be liable for the full cost of the repair (parts and labour) plus all carriage and insurance costs to and from MP Filtri premises.
- c) The product is damaged in transit and a contributory cause is inadequate packaging. It is the customer's responsibility to ensure that the packaging used to return equipment to MP Filtri is the same, or has equivalent protective qualities, to that used to ship the product to the customer in the first instance. Any damage resulting from the use of inadequate packaging will nullify MP Filtri

# WARRANTY

obligations under this warranty. Should the customer's product be damaged in transit following a repair at MP Filtri site, a full photographic record of the damage must be obtained (packaging and the product) to support any claim for recompense. Failure to present this evidence may limit MP Filtri obligations under this warranty.

THIS WARRANTY IS GIVEN BY MP FILTRI IN LIEU OF ANY OTHER WARRANTIES, EXPRESS OR IMPLIED, INCLUDING BUT NOT LIMITED TO ANY IMPLIED WARRANTY OF MERCHANTABILITY, NON INFRINGEMENT OR FITNESS FOR A PARTICULAR PURPOSE. MP FILTRI LTD SHALL NOT BE LIABLE FOR ANY SPECIAL, INDIRECT, INCIDENTAL OR CONSEQUENTIAL DAMAGES OR LOSSES ( INCLUDING LOSS OF DATA), WE SPECIFICALLY DISCLAIM ANY AND ALL WARRANTIES TO CUSTOMERS OF THE CUSTOMER. THE CUSTOMER'S SOLE REMEDY FOR ANY BREACH OF WARRANTY IS THE REPAIR OR REPLACEMENT, AT MP FILTRI DISCRETION, OF THE FAILED PRODUCT.

MP Filtri Ltd maintains a policy of product improvement and reserves the right to modify the specifications without prior notice

## 3.1 Warranty on Recalibration

The ICM 4.0 is guaranteed for 12 months upon receipt of the ICM 4.0, subject to it being used for the purpose intended and operated in accordance with this User Guide.

MP Filtri UK will only verify the accuracy of the ICM 4.0 if the unit is recalibrated every 12 months.

Please ensure that the test results in the Log are downloaded to LPA-View before the ICM 4.0 is despatched, in case action taken by MP Filtri UK during the service / recalibration causes the Log to be cleared.



**NOTE**

It is requested that only the ICM 4.0, not the ancillaries, be returned for recalibration. MP Filtri UK will not be held responsible for any items returned as such. Ensure that the ICM 4.0 is packed appropriately for transportation.

## 4. Technical specification

### 4.1 Performance

Technology	LED Based Light Extinction Automatic Optical Contamination Monitor
Particle Sizing	>4, 6, 14, 21, 25, 38, 50, 70 $\mu\text{m}$
Analysis range	ISO 4406 Code 0 to 25 NAS 1638 Class 00 to 12 AS4059 Rev E Table 1 & 2 Sizes A-F: 000 Please Note: (Lower Limits are Test Time dependent) If system cleanliness is expected to be above 22/21/18 or approx. NAS 12
Calibration	Each unit individually calibrated with ISO Medium Test Dust (MTD) based on ISO 11171, on equipment certified by I.F.T.S. ISO 11943
Moisture & Temperature Measurement	% RH (Relative Humidity) $\pm 3\%$ and fluid temperature $\pm 3^{\circ}\text{C}$ ( $\pm 5.4^{\circ}\text{F}$ ) Mineral Oil / Diesel version only
Accuracy	$\pm 1/2$ ISO code for 4, 6, 14 $\mu\text{m}_{(c)}$ $\pm 1$ code for 21, 25, 38, 50, 70 $\mu\text{m}_{(c)}$

### 4.2 Electrical Interface

Supply Voltage	9-36V DC
Supply Current	12V      24V      36V 150mA    80mA    60mA    K version 70mA    40mA    30mA    NON-K version
Power Consumption	2.2W max
Test Time	Adjustable 10 - 3600 seconds (factory set to 120s)
Data Storage	Approximately 4000 timestamped tests in the integral ICM 4.0 memory
Keypad & LCD	6 keys, 128x64 pixels, back-lit graphical display
Communication Options	Integrated WIFI RS485 Modbus CANbus 4-20mA

# TECHNICAL SPECIFICATION

## 4.3 Physical Attributes

Dimensions	142 mm / 5.59" (W) x 65 mm / 2.55" (D) x 123 mm / 4.84" (H)
Mounting	2 holes Ø7 mm 126 mm apart
Weight	1.6 kg / 3.53 lbs
Connections	G1 M16x2 hydraulic connection G3 1/4" BSPP Female Port G4 7/16 UNF Female Port
Seal Material	M/N Version - Viton® (contact MP Filtri for any fluids that are incompatible with Viton® seals) S Version - Perfluoroelastomer (FFKM)

## 4.4 Fluid Characteristics

Fluid compatibility	M version - Mineral oil and synthetic fluid N version - M type fluids & Subsea fluids and water based fluids S version - M & N type fluids & phosphate esters/aviation fluids - G3 port option only
Viscosity	Up to 1000 cSt
Fluid temperature	-25°C to +80°C
Operating Flow Rate	20-400 ml/min
Maximum Pressure	420 bar / 6092 psi static (for high frequency pressure pulse applications contact MP Filtri UK)
Differential Pressure	Typically 0.5 bar / 7.25 psi

## 4.5 Environment

Ambient working temperature	-25°C to 80°C non K version / -25°C to 55°C K version
IP Rating	IP65/67
IK Rating	IK04

## 4.6 Wetted parts list

M Version	N Version	S Version
Copper Alloy C46400	Stainless Steel	Stainless Steel
Stainless Steel	Sapphire (Al <sub>2</sub> O <sub>3</sub> )	Sapphire (Al <sub>2</sub> O <sub>3</sub> )
Sapphire (Al <sub>2</sub> O <sub>3</sub> )	Viton®	Perfluoroelastomer
Viton®	PTFE	PTFE
PTFE		EPDM
FR4		

## 4.7 Dimensions

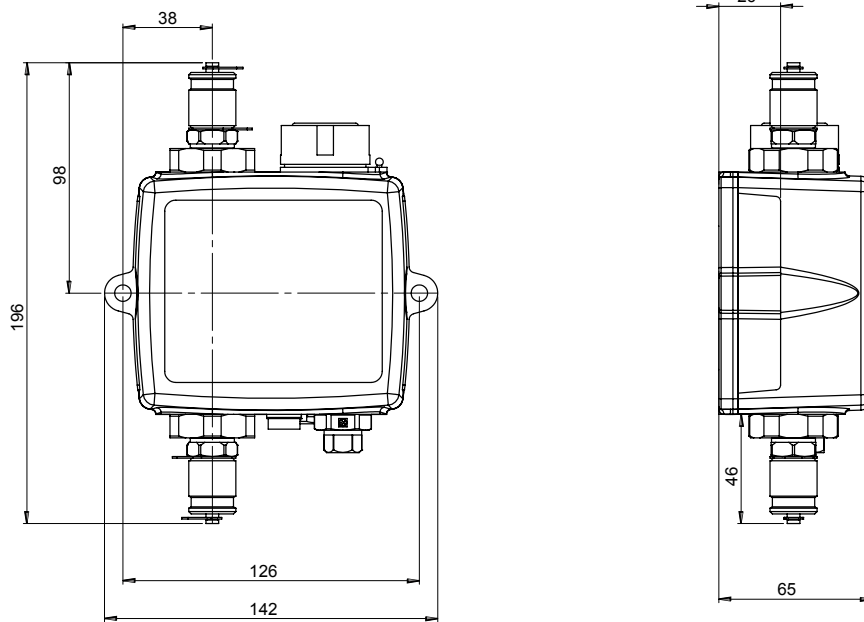

It is important to ensure a minimum 0.5Bar differential across the ICM4.0  
 The ICM 4.0 can be used as a standalone product or can be controlled by external PC, PLC.

## 4.8 Designation & Ordering code

### AUTOMATIC PARTICLE COUNTER ICM 4.0

Series	Configuration example:	ICM	W	M	K	R	G1	4.0
<b>ICM</b> In-Line Contamination Monitor								
<b>Moisture Sensor (RH%)</b>								
<b>O</b> Without moisture and temperature sensor								
<b>W</b> With moisture and temperature sensor								
<b>Fluid compatibility</b>								
<b>M</b> Mineral/synthetic oils								
<b>N</b> Subsea and water based fluids (*)								
<b>S</b> M & N type fluids & phosphate esters/aviation fluids (*) - G3 port option only								
<b>Keypad / Display</b>								
<b>O</b> Without LCD and keypad control								
<b>K</b> With LCD and keypad control								
<b>Device output</b>								
<b>R</b> With relays / external alarm outputs								
<b>Connections</b>								
<b>G1</b> M16 x 2 test points								
<b>G3</b> 1/4"BSPP female ports								
<b>G4</b> 7/16th UNF female ports								
<b>Series</b>								
<b>4.0</b> ICM 4.0 with integral WiFi								

(\*) **N** and **S** version, moisture sensor (**W**) not available

# TECHNICAL SPECIFICATION

## 5. Product Installation and General Operation

### 5.1 Installation

Scope of supply:

- ICM 4.0
- Calibration certificate
- USB Stick which includes: Product User Guides, LPA-View software, accessory product drivers and product brochures
- Pre-wired 3m cable
- Quick Start Guides

Optional Equipment:

- 11.112: 3m twisted pair cable assembly
- ICMRDU 2.0 Remote display unit
- 11.615: 600um coarse screen filter, 1/4"BSPP Female ports
- ICMFC1 Flow Control Valve
- ICMUSBi USB adaptor with pre-wired ICM cable
- ICMETHi RJ-45 adaptor with pre-wired ICM cable

#### 5.1.1 Physical Procedure

- Decide on tapping points in hydraulic circuit
- Locate the unit mechanically and bolt to desired location using fixing holes provided. The ICM 4.0 must be in a vertical orientation, with the oil flowing upwards through it
- Wire back to junction box
- Check flow in acceptable range. There needs to be a differential pressure of more than approximately 0.5 bar placed across the ICM 4.0, such that a flow of fluid is generated within the range of the unit.
- If there is no suitable differential pressure available, then a flow controller will be needed. One solution is the ICM-FC1 pressure compensated flow control valve. This limits the flow to around 200ml/minute for differential pressures up to 400 bar. This should be fitted to the drain side of the ICM 4.0 (the top fitting).
- Fix mechanically
- Connect hoses or hard pipe from the system
- There must be no extra restriction placed in the drain hose. Do not have a pipe going to a restrictor to control flow. Any such restrictor must be mounted directly to the ICM 4.0 drain fitting. (A) - Fluid flow must be from the bottom fitting to the top, following the direction of flow arrow on the product labelling i.e. the bottom fitting is the inlet and the top fitting is the outlet.
- Fit electrical connector, wire back to a junction box.

(A) This is because any length of pipe between the ICM 4.0 and a downstream restrictor can act as an accumulator. Any pressure pulsations (for example from a pump) in the feed to the ICM 4.0 are then translated into pulsations in flow rate, sometimes leading to flow reversals in time with the pulsations. If the flow is very low this can sweep the same particle backwards and forwards through the sensing volume multiple times, confusing the results.

## 5.1.2 Electrical Interface

MP Filtri's separate ICM-USBi product is available for those wishing to have a simple plug and play solution providing both mains power and connection of the ICM 4.0 to a computer (note: internally, there is also a secondary terminal connection for hard wire of external alarm outputs). This section is for those wishing to do their own wiring to the product.

### 5.1.2.1 Electrical Connectors

PIN	COLOUR	'MACHINE' CONNECTOR	'REMOTE' CONNECTOR
1	Yellow	RS485+/CANL/4-20mA(A)	RS485+
2	Pink	START INPUT	
3	Green	RS485-/CANH/4-20mA(B)	RS485-
4	White	OUTPUT 1	
5	Grey	I/O COMMON	
6	Brown	OUTPUT 2	
7	Blue	DC 0V	DC 0V
8	Red	DC +POWER	DC +POWER

#### 5.1.2.1.2 Machine Connector

The connector is intended for permanent connection to the PLC / machine USBi device that powers the ICM 4.0 during normal operation. It has power connections, a start signal input, two relay outputs, and a data pair that can be set to RS485, CANbus or 4-20mA signaling modes.

This is the circular connector closest to the hydraulic connection, see figure 5.1.

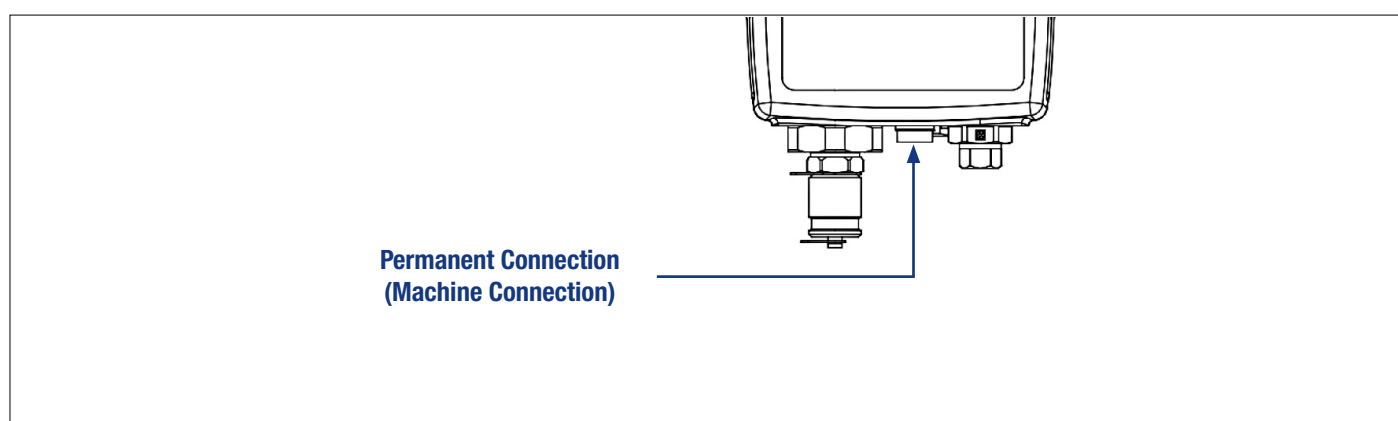

Figure 5.1 Connector Orientation



# PRODUCT INSTALLATION

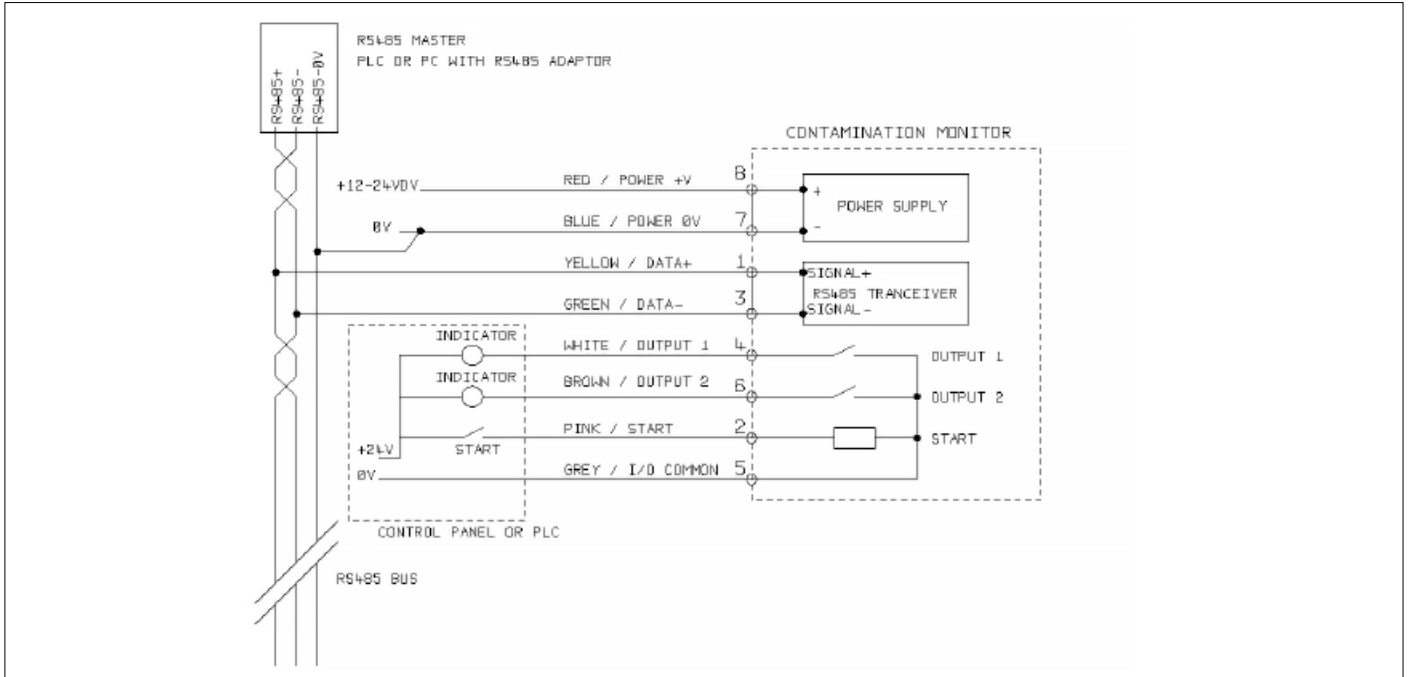

Figure 5.2 Connector - External Wiring Example

## 5.1.2.2 DC Power

DC power is connected to pins 7 and 8 of either circular connector (Red and Blue if using the pre-wired cable). All the other signals are optional.

Item	Minimum	Maximum
Voltage	9V DC	36V DC
Current	-	200mA

### 5.1.2.3 Connector - Serial Interface

An RS485 or CANbus interface can optionally be connected to pins 1 and 3 (yellow and green). This can be a PLC running customer software, or a PC with a RS485 adaptor running the supplied LPA-View software. To provide a reference the RS485 0V connection should also be linked to the ICM 4.0 0V (as shown on figure 5.3).

The standard ICM 4.0 control protocol is Modbus RTU. Modbus is a freely available open standard for industrial control. Adapters are available to interface to other industrial control busses. The standard LPA-View software from MP Filtri UK itself uses Modbus to communicate with the ICM 4.0, but it is also possible for customers to implement their own controllers (section Modbus).

The CANbus protocol can also be used, see separate ICM-CANbus manual.

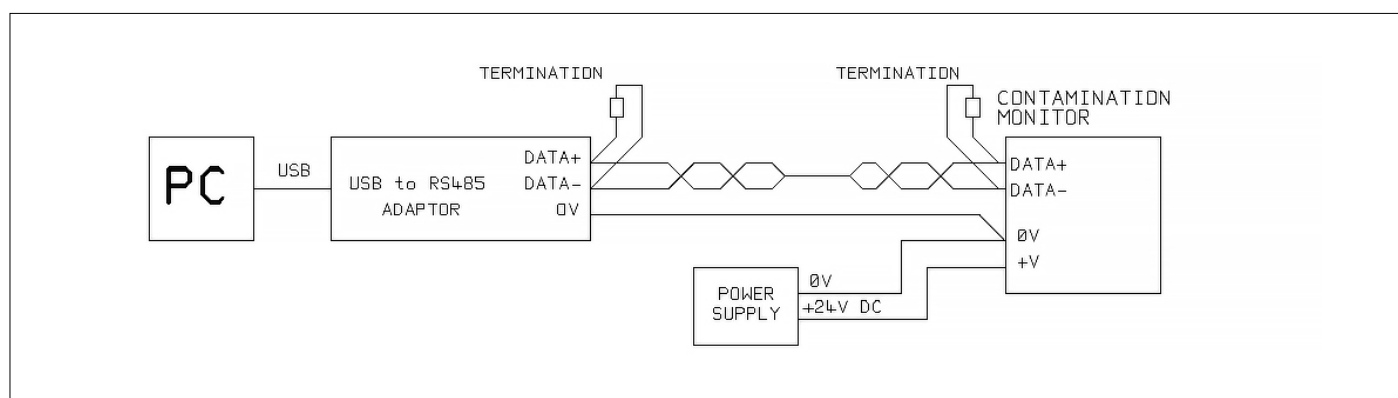

Figure 5.3a PC Control Example

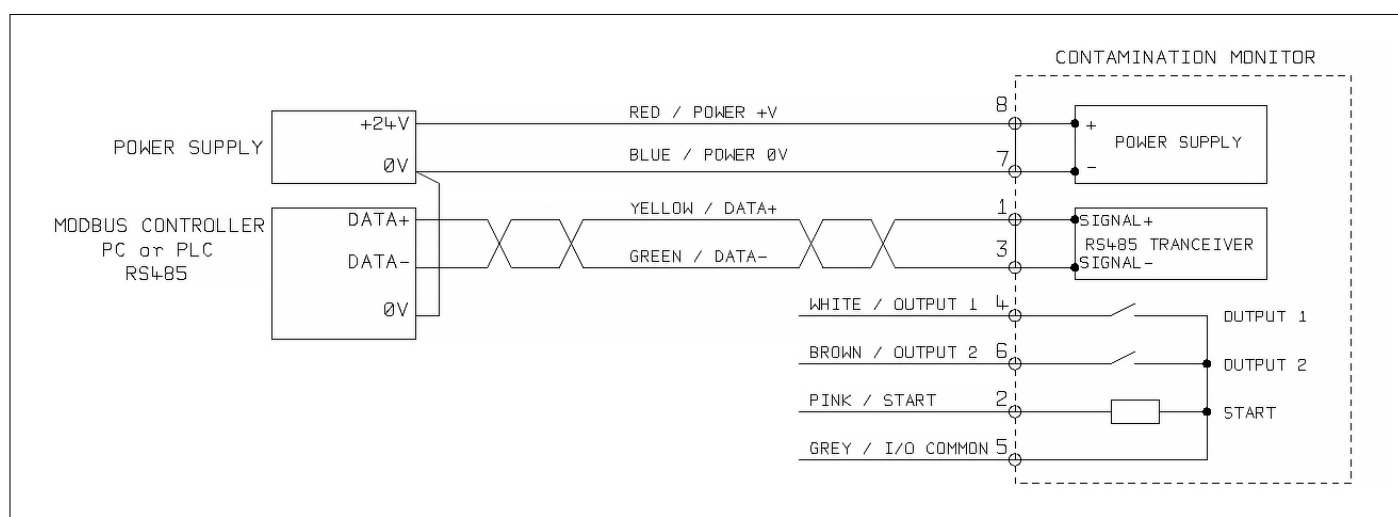

Figure 5.3b Modbus Controller Example

Figure 5.3a shows a single ICM 4.0 linked to a PC, using a USB-RS485 adaptor. Figure 5.3b shows a slightly different method. 100 Ohm termination resistors should be fitted as shown for long cables, for example over 10m. Twisted pair wiring should be used for any length over 2m.

# PRODUCT INSTALLATION

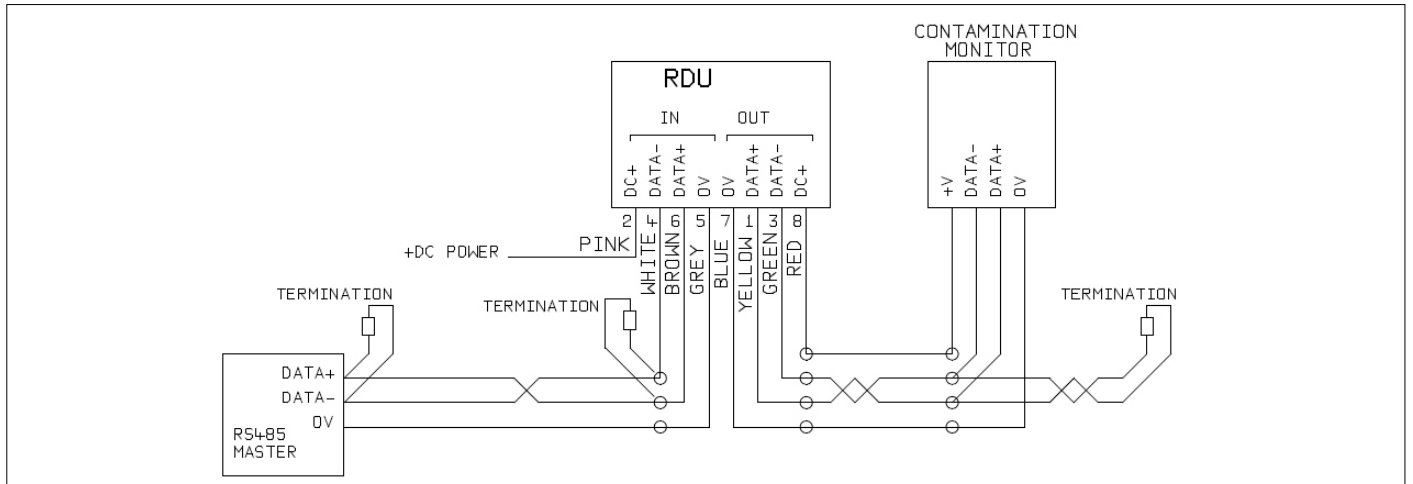

Figure 5.4 Remote Display Unit Including PC Controller Example

Figure 5.4 shows how to connect the ICMRDU Remote Display Unit. The RDU is used when the ICM 4.0 location is not convenient for an operator. It can control and monitor a remote ICM 4.0, as well as allowing an external controller to be connected to it (for data download, for example).

## 5.1.2.4 Switched Input and Output Signals

The ICM 4.0 has one switched input and two switched outputs. These can be used instead of, or in addition to, the RS485 interface for command and control. The RS485 interface is more flexible but requires more software work if LPA-View is not used (e.g. control from a PLC). An alternative is to control the ICM 4.0 via these switched I/Os, either from a PLC or using a manual switch and indicators.

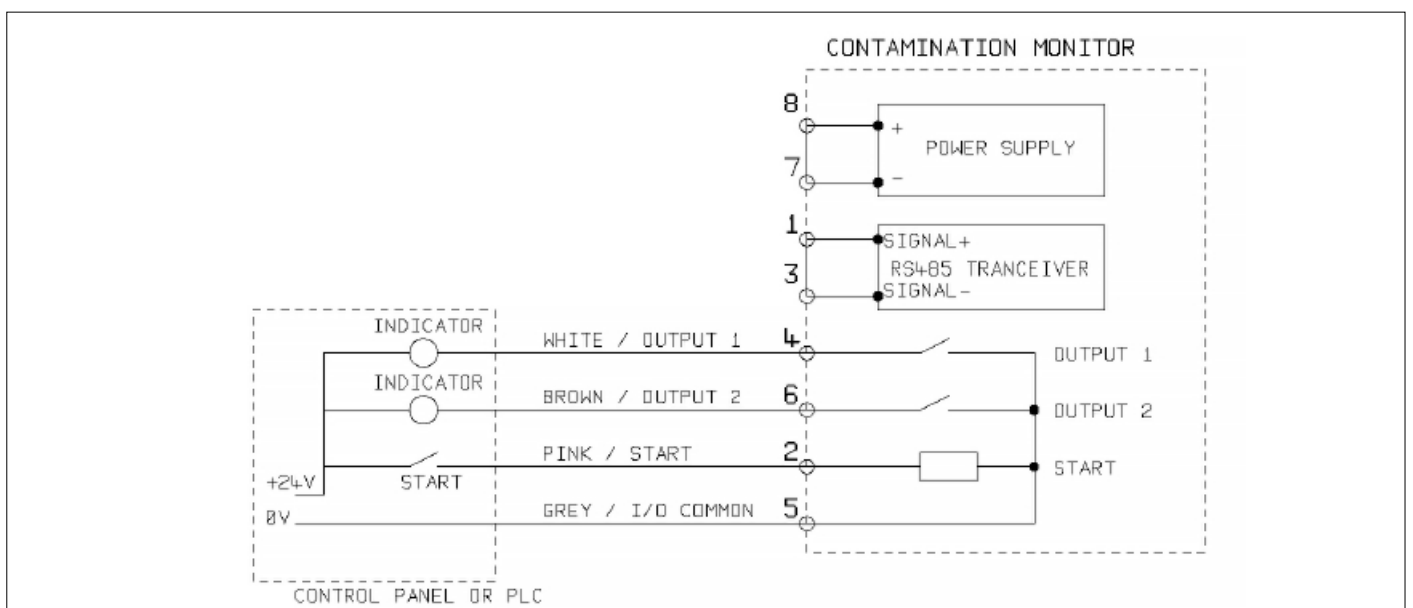

Figure 5.5 Switched I/O Signals

In order to reduce wiring the input and outputs all connect together on one side (see Figure 5.5). However they are optically isolated from the rest of the system so can be used to switch unrelated signals.

### 5.1.2.5 Start Signal

The “start signal” is an opto-isolated input that can be used to start a test, it can be used to ensure testing only occurs when the hydraulic system is running. For example, the start signal could be wired to go on and off with the main hydraulic pump or with a solenoid valve that allows fluid flow. That way the log does not fill up with invalid tests that were carried out with no flow.

This could be from a push button or a PLC output. The input accepts AC or DC signals, typically derived from the DC supply voltage. The exact function of this input is determined by the Test Mode setting.

Item	Minimum	Maximum
Voltage	9V DC	36V DC
Impedance	10k Ohms	-

- When the START signal transitions from OFF to ON, the unit will start a new test or restart any test in progress.
- At the end of the test, the state of the START signal is checked
- If the START signal is still on at the end of a test, another test is started. So that testing continues while the START signal is held on.
- The switching off the start signal will operate as a STOP command. That is, it will abort any test in progress. It will continue to show and report the previous result.
- This new operation mode applies whether or not continuous testing is enabled.
- So for example if “continuous testing” and “stop testing when clean” are both enabled, and if the start signal is being held on throughout testing, then EITHER the start signal vanishing OR a clean result can terminate testing.
- This is not the same thing as the “start signal delimited test” option (“start signal defines test duration” in user settings when enabled). This is for using the start signal to control the duration of each \*single\* test, only.

Other ways to test are:

- From the ICM 4.0 front panel START button, if fitted (K Keyboard option)
- Via LPA-View or PLC Modbus command
- Periodic automatic testing according to a programmed test mode

# PRODUCT INSTALLATION

## 5.1.2.6 Alarm Outputs

These are opto-isolated switches that can be used to signal external indicators, PLC inputs or other equipment (e.g. pump on/off control).

The exact function of these outputs is determined by the Alarm Mode setting (section 5.3.3.9).

The outputs are “voltage free” contacts that can switch AC or DC signals up to 36V nominal (60V absolute maximum peak voltage).

Item	Minimum	Maximum
Voltage	-	36V DC
Current	-	0.5A

## 5.1.2.7 4-20mA Connection

See Figure 5.6 for a schematic.

The two 4-20mA outputs are sourced from the main supply voltage DC+. These may be connected to the 4-20mA inputs of a process indicator or a PLC. The 0V connection is then also normally connected to the PLC 0V.

The 4-20mA outputs can be converted to 0-5V outputs by connecting a 250 ohm resistor between each output and 0V. Similarly they can be converted to 0-10V outputs by connecting 500 ohm resistors.

For details of how the test results are represented by the 4-20mA signals, see section 5.4.3.

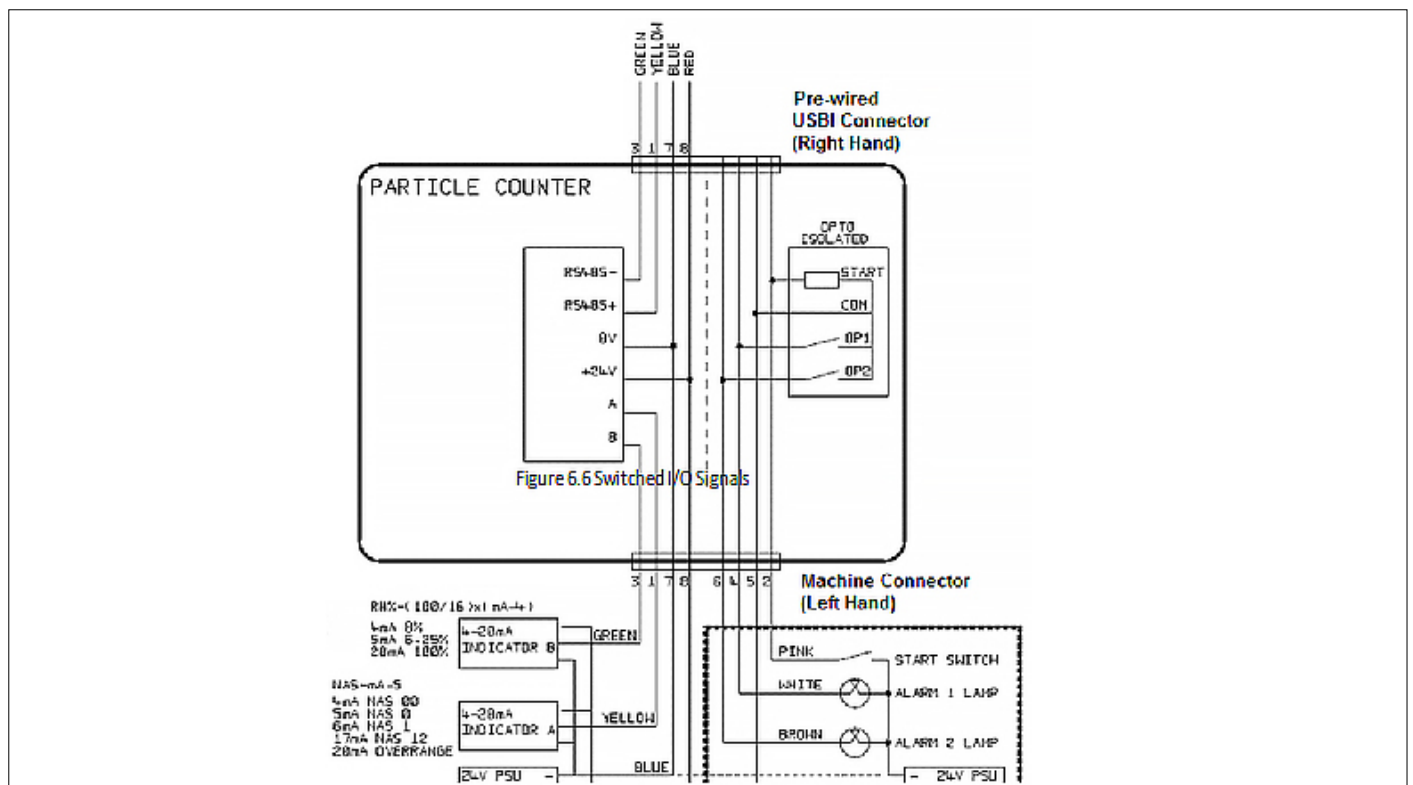

Figure 5.6 4-20mA Example

## 5.1.3 Hydraulic Connection

### 1 High or Low Pressure Parallel Connection

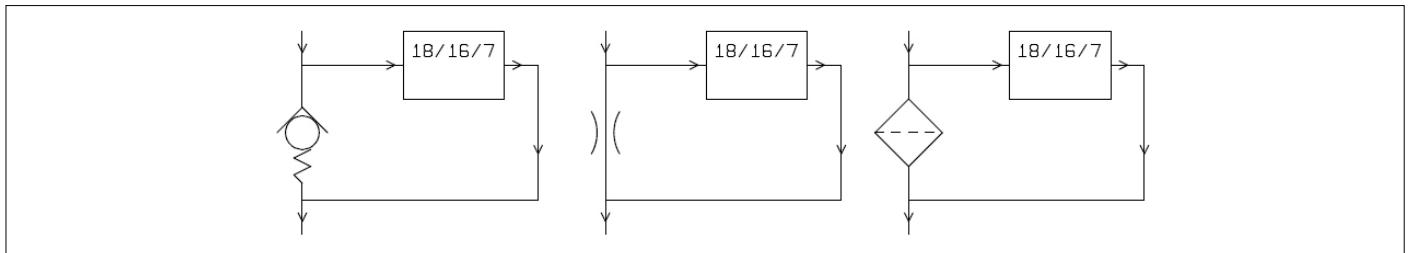

Figure 5.7 ICM 4.0 working pressure generated by hydraulic component

### 2 Low Pressure, Off-Line Operation

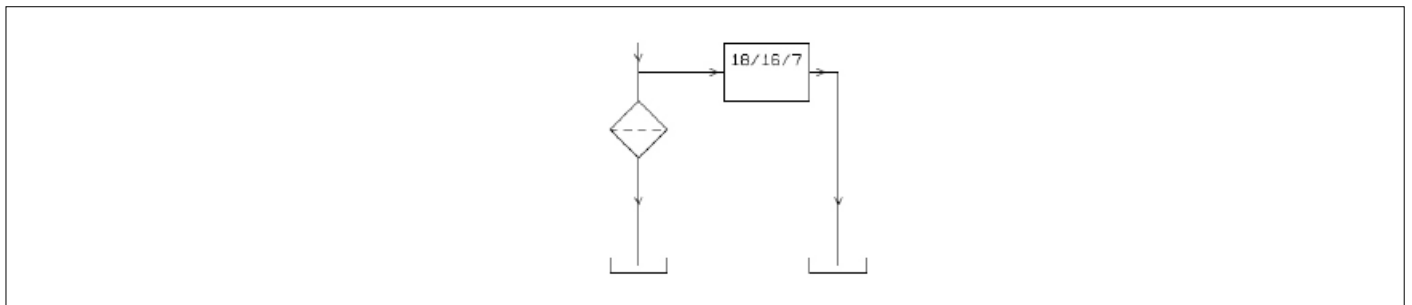

Figure 5.8 ICM 4.0 working pressure generated by hydraulic component

### 3 Very Low Flow Systems

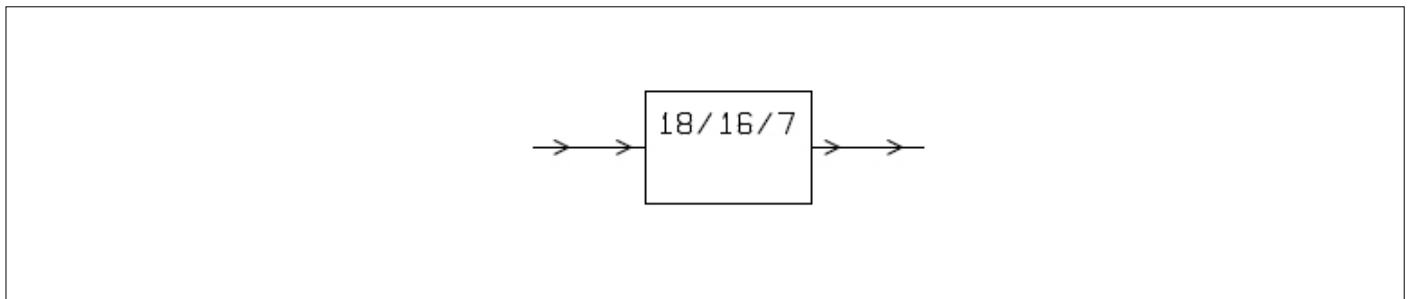

Figure 5.9 Entire system flow rate is within the range of the ICM 4.0

# PRODUCT INSTALLATION

## 5.1.3.1 Flow Rate

For the majority of systems, a differential pressure of a few bar will generate an in-range flow for an ICM 4.0 connected using two 1.5 meter lengths of microbore pressure hose. The required differential pressure can be obtained by taking advantage of an existing pressure drop within the system. Alternatively one can be created by inserting a check valve. The ICM 4.0 can then be connected across this differential pressure source.

### 5.1.3.1.1 Detailed Calculations

In general the flow rate of fluid through the ICM 4.0 needs to be kept within the range of the unit (see hydraulic specification). The ICM 4.0 measures the flow during operation, so this can be used to check that the flow is correct.

A flow that is out of range will be indicated by a fault code.

Note: Results taken with out-of-range flows are not logged.

The flow is entirely generated by the differential pressure between the ends of the pipes used to connect the ICM 4.0. The pressure needed to generate an in-range flow can be estimated by assuming a target flow, and determining the resulting pressure drop across the ICM 4.0 and connection piping. Use Figure 5.9 to lookup the ICM 4.0 pressure drop, and manufacturers' data to lookup the piping pressure drop at the desired flow. The sum of these two pressures is the pressure needed.

The user connects the ICM 4.0 between two points in the hydraulic circuit that have this pressure difference.

In order to use the graph:

- Determine the working viscosity of the fluid, e.g. 30 cSt
- Decide on a desired flow rate. 200ml/minute is normally used since this is in the middle of the ICM 4.0 flow range. But 100ml/minute is also suitable and uses less oil
- Use the figure 5.10 to look up the pressure drop, across the ICM 4.0 ports, at this flow rate and viscosity. E.g. at 30cSt and 200ml/minute, this is 0.4 bar. The maximum and minimum allowed differential pressures can also be determined using the 400ml/min and 20ml/min lines, respectively.
- Determine the additional pressure drop caused by the piping used to connect the ICM 4.0. This may be negligible for 1/4 inch piping and over, but is very important for microbore hoses. This information can be found in the manufacturers catalogues. In the case of microbore hoses, at 30 cSt these have a pressure drop of around 10 bar per meter per lpm of flow. So a 2m total hose length would add a pressure drop of  $2 \times 10 \times 0.2 = 4$  bar. (So in this case the pressure-flow relationship is mainly dependent on hose resistance).
- Add the ICM 4.0 pressure drop to that of the hoses, e.g.  $4 + 0.4 = 4.4$  bar

When the required pressure drop has been found:

- See the figures at the start of this section for examples of where the ICM 4.0 could be connected
- If there is a pair of connections in the hydraulic circuit that operates with a differential pressure near to that calculated, then the ICM 4.0 can be connected there
- Alternatively, create the pressure drop by modifying the hydraulic system. For example, insert a check-valve in the circuit with a 4 bar spring. The "component" could also be a filter, a restrictor or even a piece of piping if it has a suitable pressure drop across it.
- If none of these options is feasible, then an active flow controller will likely be needed, see 5.1.2.3.

- Otherwise connect the ICM 4.0 across the points identified; taking care to maintain an upward flow of oil through the unit (this reduces trapped air).
- Of course in a real system the pressure and viscosity will vary with temperature and operating conditions. But since the working flow range of the ICM 4.0 is very wide, this should not be a problem provided it remains within range. On the graph the area between upper and lower lines represents the usable operating region for the ICM 4.0, with the middle line being ideal. The differential pressure and the viscosity can vary from the ideal, provided the system stays within the upper and lower lines. This ensures the flow stays within the working range of 20 - 400 ml/min. It can be seen that the unit will accommodate a 20:1 variation in either viscosity or differential pressure during operation.

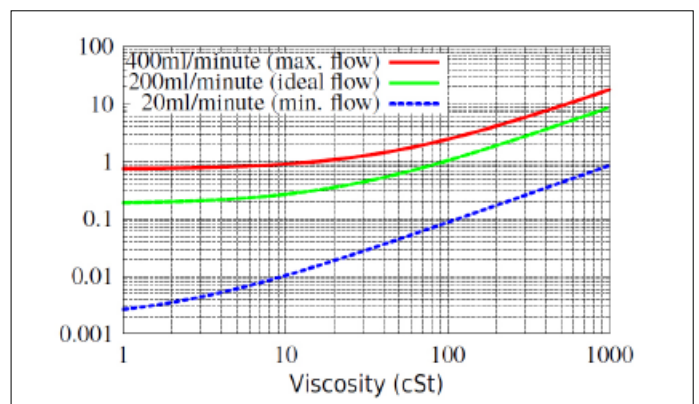

Figure 5.10  
Differential Pressure vs Fluid Viscosity,  
for various flow rates

### 5.1.3.2 Manual Flow Control

Another possibility is to fit a simple manual flow control (flow restrictor) to the outlet of the ICM 4.0.

- This should only be done where the available pressure is less than twice the maximum value calculated. This is because the small orifice size needed to control the flow from a pressure larger than this has a risk of blockage.
- The flow controller must be fitted to the outlet only. If fitted to the inlet it will have a filtering effect.
- The flow controller must be fitted directly to the ICM 4.0 outlet port.

### 5.1.3.3 Active Flow Control

This is only needed for operation at high differential pressures, where a too-high flow would otherwise be generated.

A pressure compensated flow control valve is fitted to the ICM 4.0 drain outlet. A suitable valve is the ICM-FC1 but other ones can be used too. This has the effect of a “flow limiter”, maintaining a constant flow rate even with a varying inlet pressure (provided this pressure stays above a minimum working value). Below this pressure the valve is wide open so has little effect, i.e. the flow will be less than the 200ml/min controlled value. This “minimum working value” will be typically 5-10 bar but will vary with viscosity. For these lower pressures a flow control valve is not needed and other methods are better used to control flow as previously described.

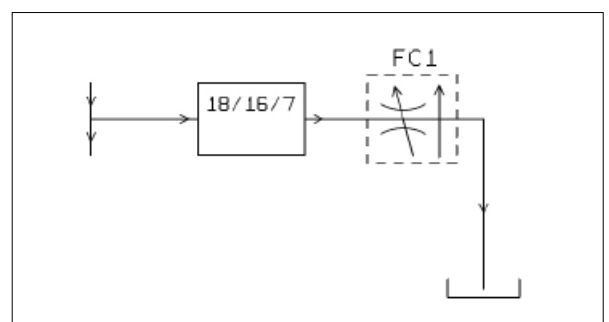

Figure 5.11  
ICM 4.0 flow actively regulated



# PRODUCT INSTALLATION

## 5.2 General Operation

### 5.2.1 Physical Checks

- Oil leaks on and around the unit
- Fatigue in hoses and pipework that might then leak when under system pressure

### 5.2.2 Front Panel Operation

#### 5.2.2.1 Status LED

All ICM 4.0 versions have a multi-colour indicator on the front panel, which is used to indicate the status or alarm state. ICM 4.0-K versions also have a screen that changes colour. The alarm thresholds can be set from LPA-View via the serial interface.



Figure 5.12 Front panel of K version (left) and Non-K version (right) ICM 4.0

Colour	Indication
Green	Indicates that the test result has passed, i.e. none of the alarm thresholds were exceeded
Yellow	Indicates that the lower cleanliness was exceeded, but not the upper one
Red	Indicates that the upper cleanliness was exceeded
Blue	Indicates that the upper water content limit was exceeded
Red/ Blue Alternating	Indicates both cleanliness and water content upper limits exceeded
Violet	Indicates that the upper temperature limit was exceeded
Red Flashing White	Various fault codes can be indicated by the LED turning red and then flashing white a number of times

Please note: If the codes seem confusing, note that a given colour will only ever be seen if the corresponding limit has been specifically set by the user. So for example if a maximum temperature limit has not been set, the violet indication will never be seen. If all that is wanted is a “green or red” light, that can be arranged by simply setting only the cleanliness threshold maximum limit.

If the upper temperature alarm is set, this takes priority over the Contamination and Water alarms. In the event of an over temperature condition, the LED will turn violet only, whether or not there is also a contamination or water alarm condition. The rationale is that an over-temperature condition could be immediately catastrophic for the hydraulic system.



## 5.2.2.2 Front Panel Operation

### 5.2.2.2.1 Result Display

ICM 4.0-K models have a 6 button keypad and a small graphical LCD. This allows the display of the test result (current cleanliness level, with water content and temperature if applicable).

The graphical format allows a full display of all codes of the standards supported.

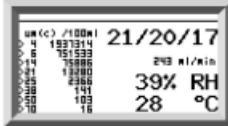
The unit powers up in “Display Mode”. This displays the test result in the selected format. The table below shows those available. The screenshots in the right column are the “detailed” version of the display additionally showing the particle counts and flow rate. The particle sizes and count representation are automatically matched to the selected format.

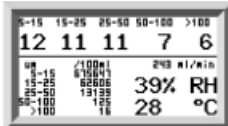
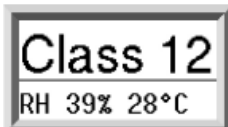
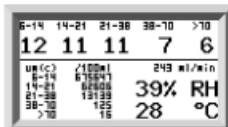
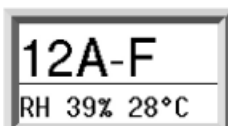
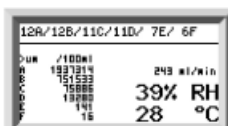
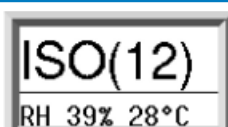
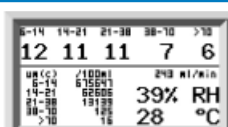
Format	Simple View	Detailed View
ISO4406:1999		
NAS1638		
AS4059E Table 1		
AS4059E Table 2		
ISO11218		

There is also a “History” screen which shows the last 10 results. The operator can switch between these screens using the v and ^ keys.

The progress of a test is denoted by the horizontal line; it grows from left to right as the test progresses.

When it reaches the right hand side a new result is generated.

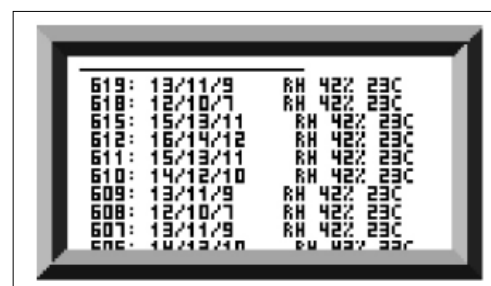

Figure 5.13 History Screen

# PRODUCT INSTALLATION

## 5.2.2.2.2 Diagnostics Display

Press < or > to show the diagnostics displays (used when diagnosing problems) shown in figure 5.14. Then switch between the diagnostics screens using the v and ^ buttons.

COMPLETION shows a number from 0 to 1000, indicating the test progress.  
 FLOW ml/min provides an approximate indication of flow rate, updated after each test.  
 NOTE: This is not a calibrated flow meter and is for indicative purposes only.

This can be helpful when installing the unit or checking operation, to ensure that the flow rate is within the limits of the unit. The other items are mainly of use to assist in support when reporting problems.

There are 5 diagnostic screens on the ICM K version:  
 Diagnostic 1 details the System Information  
 The serial number of the unit  
 The firmware installed on the unit  
 The network status, IP and Mac addresses of the integrated WiFi Chip.

Diagnostic 2 Measurements including LED level, flow rate and test completion.  
 Diagnostic 3 Hardware State - input and output switches  
 Diagnostic 4 Machine connect - Modbus details and Node address baud rate /errors  
 Diagnostic 5 Remote connect - Modbus details and Node address baud rate /errors

On the ICM4.0 the status of the machine and remote connector are combined through the single connection port. ICM2.0 has two connection ports that are reported separately.

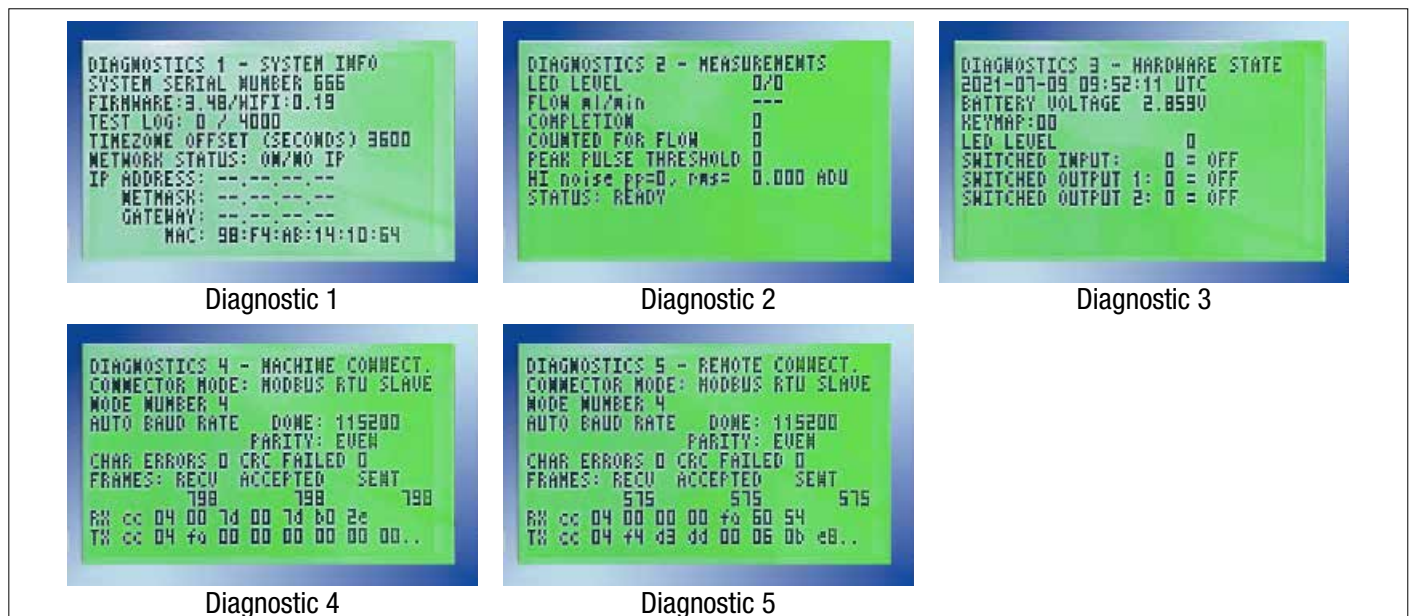

Figure 5.14 Diagnostics Screens

## 5.2.3 ICM 4.0 removal and Product Maintenance

When removing the ICM 4.0 from the system ensure the system pressure is shut off from the ICM 4.0.

- If this doesn't solve the problem then try using Iso-Propyl Alcohol or Petroleum Ether, flushing in the standard and reverse flow direction.
- If this doesn't solve the issue then send to MP Filtri for investigation.

## 5.3 ICM 4.0 Control

The ICM 4.0 can be controlled using the remote control facility included in the LPA-View software package, installed on a computer. Alternatively customers can use their own computer software.

The ICM 4.0 allows for various methods of control:

### - Direct Online Operation

The ICM 4.0 is permanently connected to a computer while tests are carried out. The operator can set parameters, type a label and initiate the test. They can then monitor the progress of each test. Each test result is displayed and downloaded into the test database as it is completed.

### - Disconnected Operation

Here the ICM 4.0 operates as a standalone item, performing tests on a schedule or under external command from a control system. If a permanent record of the results is needed, an operator can connect a computer and use LPA-View to download the accumulated test data. The ICM 4.0 can hold up to 4000 tests in the memory.

### - Wifi operation

Any of the ICM 4.0 dedicated software suite.

via CMP-View Phone application

This allows setting and download of results via the phone application.

or via CMPConnect software (included)

This allows the automatic download of results when the ICM 4.0 is connected to a wifi network.

or via Webpage monitoring

This is for live monitoring each test result via a standard web page after inputting the specific IP address of the ICM 4.0.

### 5.3.1 Computer Connection

The connection is made using an RS485 adaptor connected to the computer or control device.

The ICMUSBi is included as a pre-wired solution for USB (all modern laptops and PCs). Make the connection, start LPA-View running and then apply power to the ICM 4.0.

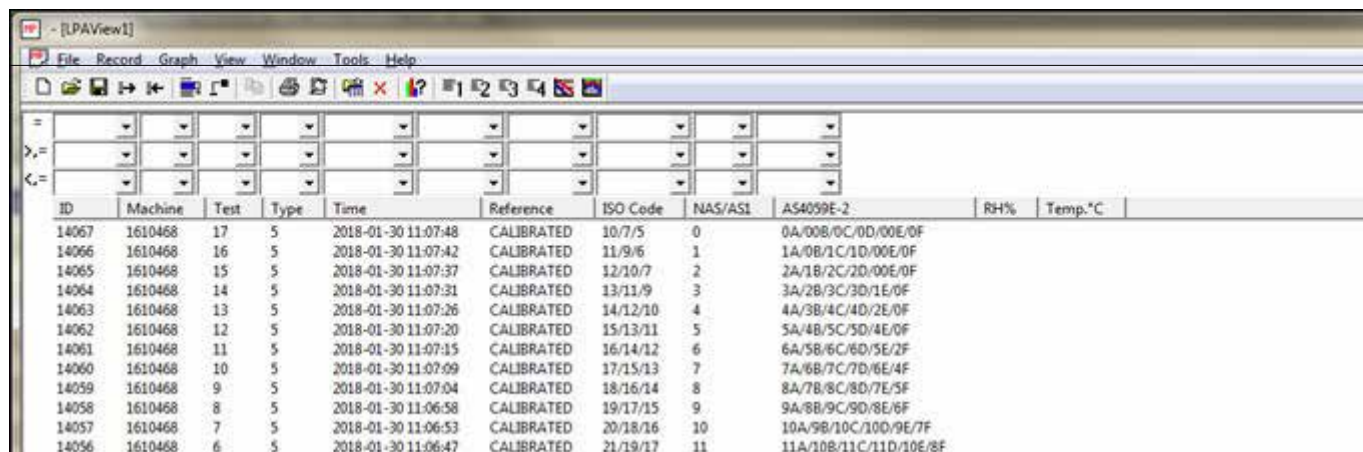

The screenshot shows the LPAView1 software interface. The main window displays a table of test results with the following columns: ID, Machine, Test, Type, Time, Reference, ISO Code, NAS/ASL, AS4059E-2, RH%, and Temp.\*C. The table contains 11 rows of data, all of which are 'CALIBRATED' tests performed on machine 1610468.

ID	Machine	Test	Type	Time	Reference	ISO Code	NAS/ASL	AS4059E-2	RH%	Temp.*C
14067	1610468	17	5	2018-01-30 11:07:48	CALIBRATED	10/7/5	0	0A/00B/0C/0D/00E/0F		
14066	1610468	16	5	2018-01-30 11:07:42	CALIBRATED	11/9/6	1	1A/0B/1C/1D/00E/0F		
14065	1610468	15	5	2018-01-30 11:07:37	CALIBRATED	12/10/7	2	2A/1B/2C/2D/00E/0F		
14064	1610468	14	5	2018-01-30 11:07:31	CALIBRATED	13/11/9	3	3A/2B/3C/3D/1E/0F		
14063	1610468	13	5	2018-01-30 11:07:26	CALIBRATED	14/12/10	4	4A/3B/4C/4D/2E/0F		
14062	1610468	12	5	2018-01-30 11:07:20	CALIBRATED	15/13/11	5	5A/4B/5C/5D/4E/0F		
14061	1610468	11	5	2018-01-30 11:07:15	CALIBRATED	16/14/12	6	6A/5B/6C/6D/5E/2F		
14060	1610468	10	5	2018-01-30 11:07:09	CALIBRATED	17/15/13	7	7A/6B/7C/7D/6E/4F		
14059	1610468	9	5	2018-01-30 11:07:04	CALIBRATED	18/16/14	8	8A/7B/8C/8D/7E/5F		
14058	1610468	8	5	2018-01-30 11:06:58	CALIBRATED	19/17/15	9	9A/8B/9C/9D/8E/6F		
14057	1610468	7	5	2018-01-30 11:06:53	CALIBRATED	20/18/16	10	10A/9B/10C/10D/9E/7F		
14056	1610468	6	5	2018-01-30 11:06:47	CALIBRATED	21/19/17	11	11A/10B/11C/11D/10E/8F		

Figure 5.15

# PRODUCT INSTALLATION

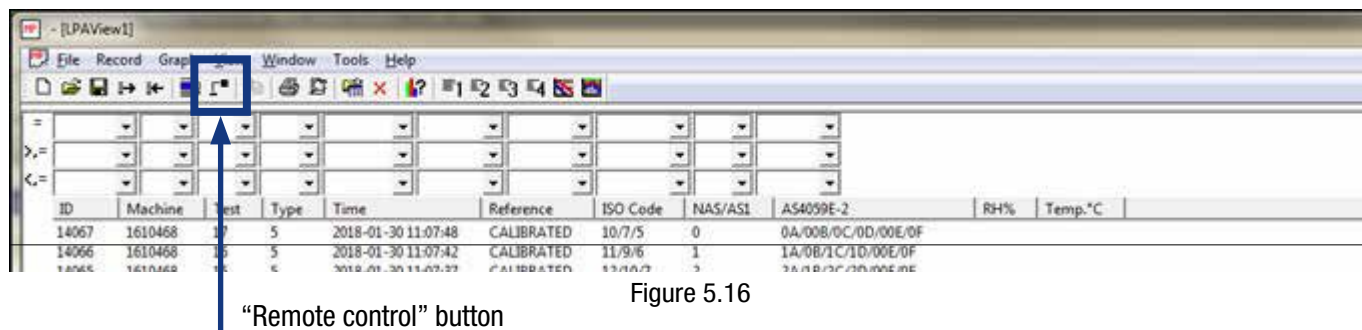

To access the Remote Device facility in LPA View, press the Remote Control button on the toolbar (7th button from the left on the toolbar - Figure 5.16). The Connect dialogue will then appear (Figure 5.17).



Figure 5.17

The first time that this is done, the correct communications port (COM port) on the computer has to be selected, as detailed below. The program scans the computer for available ports, and puts them in a list to choose from - this list is in the box above the Connect button. Press the arrow on the right hand side of this box and choose the connection on your computer.

All working communication ports of the computer are available for selection. Select the one used to connect the ICM 4.0, and then press OK. If you are unsure which port is correct, the device name should be next to the COM port number. When communication has been established successfully, the remote control dialogue will appear. After a successful connection, the COM port will be remembered for next time and will appear preselected in the dialogue. If no COM ports appear, please refer to the fault finding section the manual.

## 5.3.2 PC Software Operation

The Remote Control dialogue allows an operator to manually control the ICM 4.0 from a laptop, using the LPA-View software. It can also be used to download test results that have accumulated during autonomous (disconnected) operation.

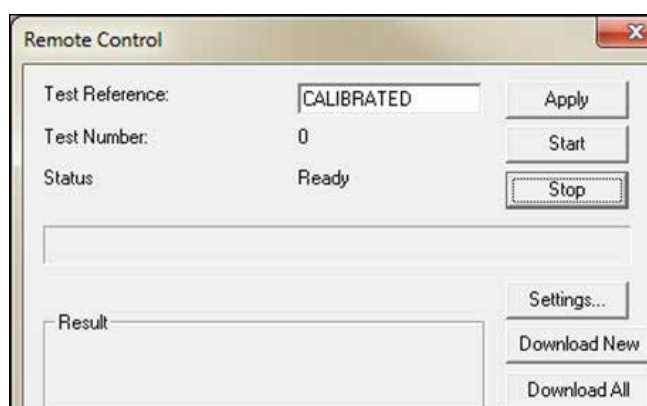

Figure 5.18



To perform a test, first optionally edit the Test Reference and press Apply to register the new value. This is a descriptive label which can be used to identify or group the test later (along with the test number and test time/date). An example would be a machine number or customer name. The Test Reference can be up to 15 characters in length.

When connected the ICM 4.0 status should show “Ready”. The operator can then press the Start button to begin the test. The progress bar shows how much of the test has been completed.

The test can be abandoned at any time by pressing the Stop button. If the Start button is pressed during a test, then the current test is abandoned and a new one started. When the test has finished, the Result area will display the contamination level in the set format and water content and temperature (if applicable).

After a test the Test Number is automatically incremented and the status of the test is displayed. If the status is Ready then the operator can press the Start button again to begin a new test.

It is also possible to configure the ICM 4.0 to automatically begin another test, after an optional delay. In this case the status will be Testing or Waiting.

The ICM 4.0 incorporates a data logger, so previous test results can be downloaded into the test database using the Download New and Download All buttons. The difference between these is that Download New only transfers results that have never been downloaded before. Download All transfers all results that are stored in the ICM 4.0. Erase Log deletes the test results from the memory of the ICM 4.0, see figure 5.18.

When the user has finished operating the ICM 4.0 the dialogue can be dismissed using the close control (the “X” at the top right corner of the dialogue) or by pressing the Esc key. Pressing the Settings... button brings up the Remote Device Settings dialogue. The ICM 4.0 has an integral memory of 4000 test records, once the memory is full the earliest test records are overwritten. To avoid loss of data, regular test record downloads should be carried out.

### 5.3.3 Settings

The ICM 4.0 can be reconfigured using the Remote Device Settings dialogue. This is normally done as part of the installation or commissioning process. After making any changes, pressing the OK button will update the ICM 4.0 with the new settings. Or press Cancel to leave the settings as they were.

NOTE: The ICM 4.0 has been designed to be a very flexible product, so has a wide range of settings and operating modes. However the shipped defaults are suitable for most applications and many users can skip this section. Actual operation is straightforward even when advanced settings are used during initial configuration, ee figure 5.19.

NOTE: Some items may be missing depending on the options fitted to the ICM 4.0.

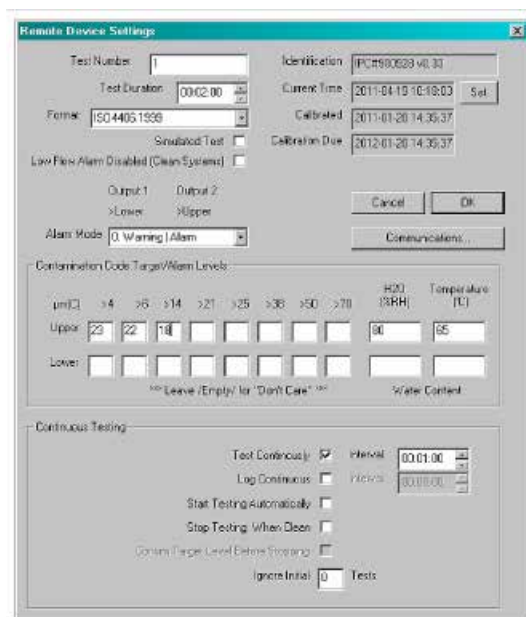

Figure 5.19

# PRODUCT INSTALLATION

## 5.3.3.1 General

Some general information about the connected ICM 4.0 unit is available. The Identification shows the ICM 4.0 serial number and software version. The serial number, together with the test timestamp, uniquely identifies the test record. These two parameters are the ones used to avoid duplication of test records.

Current Time shows the time set on the ICM 4.0. It is important that this is correct since this is used to timestamp the tests. Pressing the Set button automatically synchronizes the ICM 4.0 time to that on the computer. The calibration area displays the date last Calibrated and the next Calibration Due date.

## 5.3.3.2 Test Number

The Test Number can be used to help identify a test within a sequence. However it is automatically reset when the ICM 4.0 is powered up, so instead relying on the timestamp (date and time of test) and test reference is preferred.

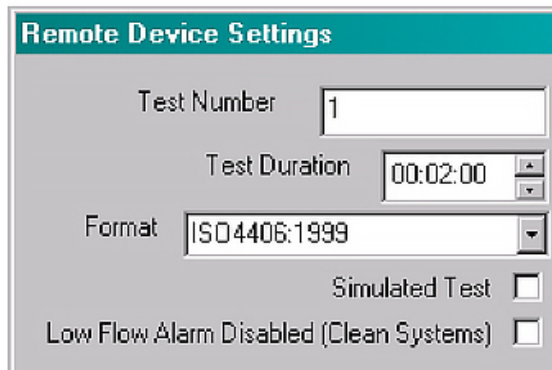

The screenshot shows a dialog box titled "Remote Device Settings". It contains the following fields and controls:

- Test Number:** A text input field containing the value "1".
- Test Duration:** A time selection field showing "00:02:00" with up and down arrow buttons.
- Format:** A dropdown menu currently displaying "ISO 4406:1999".
- Simulated Test:** A checkbox that is currently unchecked.
- Low Flow Alarm Disabled (Clean Systems):** A checkbox that is currently unchecked.

Figure 5.20

NOTE: if the ICM 4.0 is power cycled at any point then the test numbering sequence automatically resets and begins again.

## 5.3.3.3 Test Duration

The length of the test is controlled by the Test Duration, see figure 5.20 for location.

The factory set value of 2 minutes is suitable for most applications, but the user is free to set a different value. Shorter times will make the ICM 4.0 more responsive to short-term fluctuations in contamination level. It will also result in less consistent results for the large particle sizes and clean systems, due to statistical fluctuations in the number of particles counted.

Longer tests will allow more “stable” results in very clean systems and for the larger particle sizes, since there will be a larger total number of particles counted during the test. This means that any fluctuations have less of an effect on the test result.

## 5.3.3.4 Result Display

Use the selector to choose the preferred display Format (ISO, NAS etc.). This selection is not just cosmetic since it also determines how the cleanliness alarm targets are to be interpreted, if these are used. See figure 5.20 for the location, it is defined as the format.

### 5.3.3.5 Simulated Test

This setting can be used when there is no flow available but communications need to be tested. This is the box ticked in figure 5.21

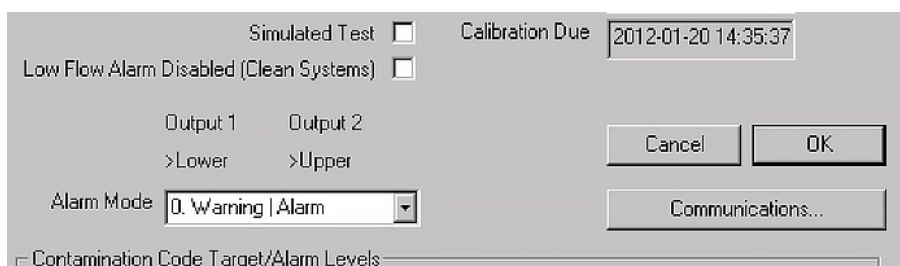

Figure 5.21

### 5.3.3.6 Low Flow Alarm Disabled (Clean Systems)

It is worth reinforcing that the primary function of the product is to produce a measurement of cleanliness, and not act as a flow meter. If the unit produces a contamination measurement, then the flow rate is sufficient enough for it to do so.

The ICM 4.0 needs particles to pass through the flow cell to calculate flow, the dirtier the system is, the more statistically accurate the flow output becomes.

Conversely, when placed on a very clean system the unit can have difficulty in working out the flow due to the very low number of particles passing through the flow cell. To overcome this, the test has to fulfil certain conditions to create a valid result.

If the low flow alarm has been disabled there must be a minimum of 20 particles >4micron seen during the test for the flow reading to be shown and the test result to be valid.

If there are less than 20 particles >4micron during the test then the ICM 4.0 will alarm/fault code even if the low flow alarm has been disabled.

Note: If the low flow alarm has been disabled, it is preferred that the ICM 4.0 is installed in such a way that if the system is shutdown (zero flow) the ICM 4.0 is also shut down so as not to measure stagnant fluid and provide erroneous readings.

It may be necessary that the low flow indicator is turned off if filtration is below 10um (ISO 14/12/10 (NAS Class 4)), see figure 5.21 for location.



# PRODUCT INSTALLATION

## 5.3.3.7 Continuous Testing

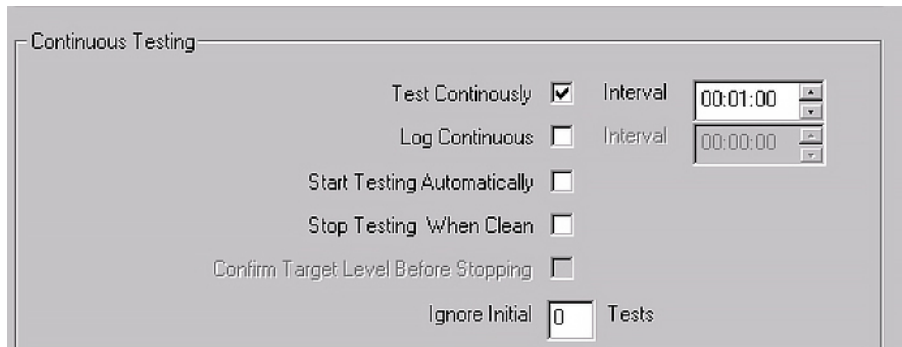

Figure 5.22

In the Continuous Testing area are settings which control how the ICM 4.0 decides when to perform and log a test. Selecting Test Continuously makes the ICM 4.0 automatically repeat the test, according to the specified Test Interval.

1. Setting an interval longer than the test duration; results in the test being repeated upon each expiry of that interval. For example, setting a Test Duration of 1 minute and a Test Interval of 10 minutes, results in a 1 minute test performed every 10 minutes - NOTE: Test time is part of interval time
2. Setting the interval to a value less than the Test Duration (for example zero); results in a new test being started immediately after a test finishes.

Log Continuous controls whether tests are logged during continuous testing. This is to avoid the test log being cluttered by potentially large numbers of unwanted test results. If Log Continuous is not selected, then only the “final” test in a sequence is logged (see Alarm Modes section and “Stop Testing When Clean” below). (\*)

If continuous logging is used, then the Log Interval can be set to control the proportion of tests that are actually logged. For example the ICM 4.0 could be set to test every 10 minutes, but only log a result hourly. The log interval, test interval and test duration are distinct parameters that work together to control the test and data logging. So that, a test duration of 2 minutes, a test interval of 10 minutes, and a log interval of 1 hour could be individually set. This would result in 2 minute long tests, repeated every 10 minutes, with a test logged hourly.

NOTE: the log interval must land on a test interval or an error will occur, for example the test interval cannot be 2 minutes and the log interval 3 minutes.

Stop Testing When Clean- This is a feature intended for cleaning rigs or “filter trolley” type applications. The ICM 4.0 continues testing until the fluid is “clean”, at which point an alarm is signaled and testing stops.

Ignore Initial Tests- on start up the number selected here is the number of tests that are ignored before results are logged. This is designed for systems that are particularly dirty or turbulent on startup and it allows the system to stabilize.

Confirm Target Level before Stopping- this helps to ensure that a test sequence is not terminated too soon, when there are still a few large particles in the system. When selected, the number in the box is how many successive “clean” results are needed before testing halts.

(\*) This feature is intended for a “Filter Trolley” type application where system runs a pump until the oil is sufficiently clean. Typically only the final “clean” result requires logging.

### 5.3.3.8 Changing Communication Protocols

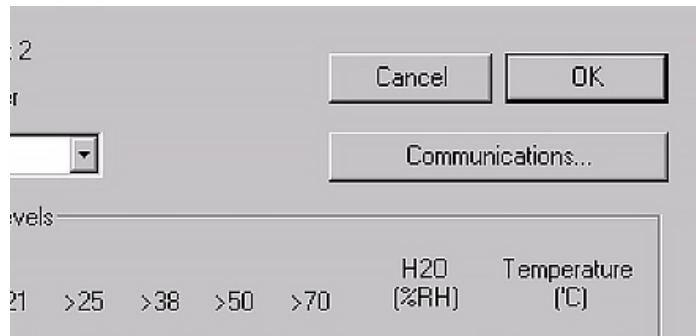

Figure 5.23

Selecting the communication button allows you to change how the ICM 4.0 communicates. See figure 5.24 for the options.

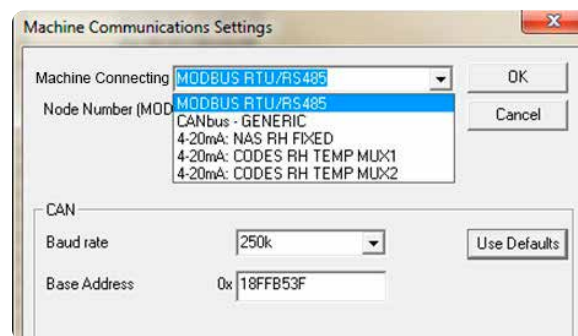

Figure 5.24

Selecting a machine interface fixes the output for the machine connector, for example selecting CANbus means that you can no longer use the machine connector to communicate in Modbus (the default). If you wish to change back or to a version of 4-20mA then you have to connect to the ICM 4.0 via the Remote Connector.

See section 5.4 for information on how to communicate with the ICM 4.0 in the different protocols.

### 5.3.3.9 Alarms

The ICM 4.0 has two switched “alarm” outputs that can be used to signal external equipment in various ways, according to the test results and the alarm settings. There is also a multi- colour front panel light which indicates how the result compares to the set alarm thresholds.

The alarm settings are comprehensive and flexible, allowing the ICM 4.0 to be used in many different scenarios.

# PRODUCT INSTALLATION

## 5.3.3.9.1 Alarm Levels

The various alarm thresholds are set in the Contamination Code Target / Alarm Levels area of the dialogue. Alarms can be set on combinations of cleanliness codes, water content and temperature. The available codes, and their interpretation, vary according to the set test Format. For example it is possible to set a threshold of “NAS 11” or “ISO 18/16/15” or “AS4059E 8B-F”, etc.

In general there are upper and lower limits that can be set for the cleanliness level, also for water content and temperature if applicable. An alarm, if enabled, will become active if any of the associated (upper/lower) limits are exceeded. However if a field is left empty (blank) this is interpreted as a “don’t care” setting.

In the example Figure 5.25 the Upper Alarm is exceeded if the 4µm count is greater than ISO code 23, or the 6µm greater than ISO code 22, or the 14µm count greater than code 18, or the water content is greater than 80% RH, or the temperature is greater than 65°C. The lower alarm is never triggered since all the settings are empty.

## ISO 4406 Alarm Levels

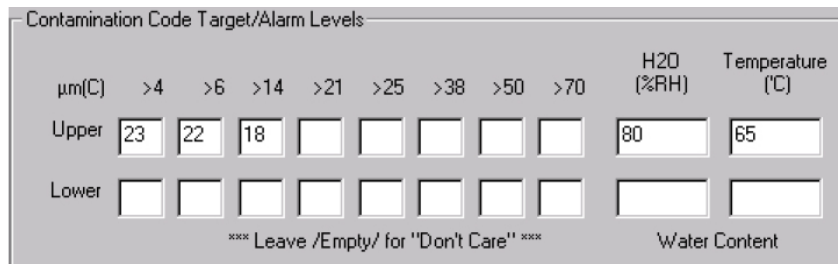

Contamination Code Target/Alarm Levels											
	µm(C)	>4	>6	>14	>21	>25	>38	>50	>70	H2O (%RH)	Temperature (°C)
Upper		23	22	18						80	65
Lower											
*** Leave /Empty/ for "Don't Care" ***										Water Content	

Figure 5.25

ISO 4406 represents cleanliness using codes for the number of particles greater than 4, 6 and 14 µm. These codes can be used as limits for the alarms by selecting the ISO 4406 test Format and then entering values as required. As an extension to ISO 4406 it is also possible to specify codes for the other measured sizes too. If this is not needed then the entries can be left blank.

## NAS1638 Alarm Levels

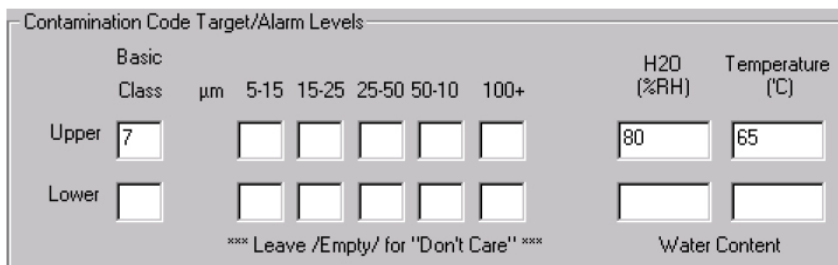

Contamination Code Target/Alarm Levels											
	Basic Class	µm	5-15	15-25	25-50	50-100	100+	H2O (%RH)	Temperature (°C)		
Upper		7						80	65		
Lower											
*** Leave /Empty/ for "Don't Care" ***										Water Content	

Figure 5.26

NAS1638 can be used by selecting this as the test Format. The headings and boxes for the available settings change appropriately. NAS1638 represents the overall cleanliness level as a single code, this being the highest of the individual codes generated for each defined particle size. Hence we have the option of setting a limit on this overall contamination class (the Basic Class), or we can set individual limits on any combination of the classes for the defined particle size ranges.

## AS4059E Table 2 Alarm Levels

Contamination Code Target/Alarm Levels									
	Basic Class	A	B	C	D	E	F	H2O (%RH)	Temperature (°C)
Upper	7	<input type="checkbox"/>	<input type="checkbox"/>	<input type="checkbox"/>	<input type="checkbox"/>	<input type="checkbox"/>	<input type="checkbox"/>	80	65
Lower	<input type="checkbox"/>	<input type="checkbox"/>	<input type="checkbox"/>	<input type="checkbox"/>	<input type="checkbox"/>	<input type="checkbox"/>	<input type="checkbox"/>	<input type="checkbox"/>	<input type="checkbox"/>
*** Leave /Empty/ for "Don't Care" ***									
Water Content									

Figure 5.27

AS4059E Table 2 uses letters instead of numbers to indicate the particle size range, so the settings are labelled appropriately. The standard specifies ways to represent a cleanliness level using only a subset of the available particle sizes, for example B-F. The user can achieve this by only entering settings for the sizes desired, leaving the others empty. So a limit of AS4059 7B-F could be represented simply by entering a value of 7 for B, C, D, E and F.

## AS4059E Table 1 / ISO 11218 Alarm Levels

Contamination Code Target/Alarm Levels									
	Basic Class	µm	5-15	15-25	25-50	50-100	>100	H2O (%RH)	Temperature (°C)
Upper	7	<input type="checkbox"/>	<input type="checkbox"/>	<input type="checkbox"/>	<input type="checkbox"/>	<input type="checkbox"/>	<input type="checkbox"/>	80	65
Lower	<input type="checkbox"/>	<input type="checkbox"/>	<input type="checkbox"/>	<input type="checkbox"/>	<input type="checkbox"/>	<input type="checkbox"/>	<input type="checkbox"/>	<input type="checkbox"/>	<input type="checkbox"/>
*** Leave /Empty/ for "Don't Care" ***									
Water Content									

Figure 5.28

These two standards are similar except for terminology and reporting format. The actual numeric sizes and class thresholds are the same.

### 5.3.3.9.2 Alarm Mode

Output 1	Output 1
<=Lower	>Upper
Alarm Mode	1. Clean   Dirty
Contamination Code	0. Warning   Alarm
Basic Class	1. Clean   Dirty
Basic Class	2. Green-Amber-Red
Basic Class	3. Particles   Water
Basic Class	4. Continue   Clean
Basic Class	5. Tested   Clean
Basic Class	6. Testing   Clean
Upper	7
	50-100 >100
	38-70 >70
	<input type="checkbox"/>
	<input type="checkbox"/>

Figure 5.29

The Alarm Mode sets the precise function of the two switched alarm outputs of the ICM 4.0.

This allows the ICM 4.0 to be used in a variety of situations. Note that the conditions under which the outputs are turned on are also displayed above the Alarm Mode selector, for each setting.

# PRODUCT INSTALLATION

NOTE: These outputs are distinct from the front panel LED, and that the set alarm mode does not affect the LED. The set alarm mode determines the function of the two switched outputs only. This setting and this entire section can be ignored if these outputs are unused, i.e. the user has not connected them to anything.

New modes are occasionally added after a customer request, this means that modes may not all be implemented unless using the latest firmware revision.

## Alarm Mode 0: Warning-Alarm

	Output 1	Output 2
Turns on when	>Lower	>Upper
Intended Function	Warning	Alarm

This allows the ICM 4.0 to switch external warning lights or alarms. Output 1 is the “Warning” output, switching on if any of the Lower limits are exceeded. Output 2 is the “Alarm” output, behaving similarly for the upper limit.

## Alarm Mode 1: Clean-Dirty

	Output 1	Output 2
Turns on when	≤Lower	Upper
Intended Function	Clean	Dirty

This could be used in a cleaning system that attempts to maintain a cleanliness level by switching a pump on and off.

Output 1 is the “Clean” output, coming on when the result is less than or equal to the lower (“Clean”) limit. This could be used to stop a cleaning pump.

Output 2 is the “Dirty” output, coming on when the result is greater than the upper (“Dirty”) limit. This could be used to start the cleaning pump.

## Alarm Mode 2: Green-Amber-Red

	Output 1	Output 2
Turns on when	<Upper	>Lower
Intended Function	Green	Red

This mode encodes the result in such a way that the internal alarm relays can be used to drive an external remote 3-colour LED indicator. This is a special type of LED containing both red and green emitters, which could be mounted in a control panel. This external LED will then turn green / amber / red according to the test result - in a similar way to the built-in one. Output 1 (“Green”) is turned on when the result is less than the upper limit. Output 2 (“Red”) is turned on when the result is greater than the lower limit. If the result is in between, both outputs are turned on and the LED colour will be amber (i.e. a mixture of red and green light).

### Alarm Mode 3: Particles-Water

	Output 1	Output 2
Turns on when	Cleanliness >Upper	Water >Upper
Turns off when	Cleanliness ≤lower	Water ≤lower
Intended Function	Cleanliness Alarm	Water Alarm

This is used when separate alarm outputs are needed for particles (cleanliness) and water content.

This mode is able to use both upper and lower limits such that the outputs have “hysteresis”. If only the upper or lower limit is required, then both upper and lower limits should be set to the same value.

### Alarm Mode 4: Continue-Clean

	Output 1	Output 2
Turns on When	>Lower	≤Lower
Intended Function	Continue Testing	Stop Testing / Clean

This is used for a “cleaning” application where a signal is needed to stop testing (for example to stop a pump or signal an external controller).

### Alarm Mode 5: Tested Not-Clean

	Output 1	Output 2
Turns on When	Test Complete	>Lower
Intended Function	Test Complete Signal	“Not Clean” Signal

This is used when controlling tests from a PLC using switched outputs. The PLC gives a start signal, then monitors the “Test Complete” output. If the test has failed it can detect this with the “not clean” signal.

*“Continuous testing” should not be selected for this mode.*

### Alarm Mode 6: Testing Not-Clean

	Output 1	Output 2
Turns on When	Testing	>Lower
Intended Function	Test in progress Signal	“Not Clean” Signal

This is similar to mode 5 above. The difference is that output 1 is active during the test and turns off at test end.

*“Continuous testing” should not be selected for this mode.*

### Alarm Mode 7... Customer Requested Modes

Other alarm modes will be defined as and when customers request them.

# PRODUCT INSTALLATION

## 5.4 Standard Communication Protocols

### 5.4.1 Modbus

The ICM 4.0 can be controlled via commands on its serial (RS485) interface, using the Modbus RTU protocol. It is possible to control every aspect and setting of the ICM 4.0, as is done by the MP Filtri UK LPA-View control software. All results and counts are available in all supported formats. We suggest using LPA-View to initially configure the ICM 4.0 and check it is performing correctly, and then the customer-written software only has to read the test results. This could be used to integrate the ICM 4.0 measurements with a general machine control, vehicle control or factory monitoring system.

Customers wishing to implement their own Modbus controller software will need to refer to the rest of this section with further details in section 8.1 and 8.2.

The simplest arrangement is to configure the ICM 4.0 to test continuously, with a set interval between tests. For example; a Test Duration of 2 minutes and a Test Interval of 10 minutes. The Start Testing Automatically selection can be used so that the unit does not require a start signal.

Then, the most recent test results can be read from the appropriate Modbus Registers.

Register	Function
56	4 µm Result Code
57	6 µm Result Code
58	14 µm Result Code

#### 5.4.1.1 Set Up

Protocol Type	RTU (not ASCII)
Data Bits	8
Stop Bits	1
Parity	Required, even or none
Baud	Auto-sensing 1200-115200
Signaling	RS485
Mode Address	4 (or user set)

Figure 5.30 Settings

##### 5.4.1.1.1 Communications Check

You should be able to read the product ID code from register 0 (from Modbus node address 204). The product ID code is the value 54237 (decimal) or 0xD3DD (hexadecimal).

### 5.4.1.1.2 Result Format

The ICM 4.0 can present results in several different industry formats (ISO, NAS etc.) The format required can be most easily set using LPA-View; however it is also possible to set it via Modbus. To do this, write the required value 0-4 from table 5A to the TEST FORMAT register 19. The factory set value is 0 (ISO 4406).

The selected format does not affect the particle count values, but does completely change the interpretation of the result codes and set limits, if used.

Note: If the format is changed, then any set alarm limits must be changed too since these will refer to the old format. E.g. a limit of “NAS 11” cannot be directly expressed using the ISO 4406 standard.

Value	Format	Main Class Example	Individual Codes Example
0	ISO 4406	-	21/20/17
1	NAS 1638	NAS 12	(12 11 11 7 6)
2	AS4059E Table 2	12A-F	12A/12B/11C/11D/7E/6F
3	AS4059 Table 1	Class 12	12 11 11 7 6
4	ISO 11218 Draft	ISO(12)	12 11 11 7 6

Table 5A TEST FORMAT Register 19

### 5.4.1.2 Result Codes

The most recent measurements are presented as numeric codes (i.e. numbers) according to the selected TEST FORMAT. These codes can be read from registers 56-63, as per Table 5B.

Register	ISO 4406 Code	AS4059E Class Table 2	NAS1638/ AS4059E Table 1/ ISO 11218 (Draft) Codes/ Classes
56	≥4 μ	Basic	Basic
57	≥6 μ	-	-
58	≥14 μ	A	5-15
59	≥21 μ	B	15-25
60	≥25 μ	C	25-50
61	≥38 μ	D	50-100
62	≥50 μ	E	100+
63	≥70 μ	F	-

Table 5B RESULT CODES Registers 56-63



# PRODUCT INSTALLATION

## 5.4.1.2.1 Null Values

For all formats, the special value -32768 (0x8000 hex) is used to represent a “null” or “no result” condition. This enables “No Result” to be distinguished from a 0/0/0 ISO code, for example. “No Result” could be due to an error condition, or to a measurement not having been commanded yet. This convention is also used for other parameters such as temperature and water content measurements, where applicable.

NOTE: User written programs should take note, to avoid displays like -32768/-32768/-32768 appearing on their front panels.

## 5.4.1.2.2 ISO 4406

ISO 4406 defines a set of code values to represent ranges of counts of particles greater than the nominated sizes of  $\geq 4$ ,  $\geq 6$  and  $\geq 14\mu\text{m}_{(c)}$ . The ICM 4.0 can display codes from 0 to 24. The three-part code is available in the first 3 RESULT CODES. We additionally make available equivalent codes for the other sizes from 21 to  $70\mu\text{m}_{(c)}$ , as per Table 5B.

## 5.4.1.2.3 NAS 1638/ AS4059E-1/ ISO11218

These assign code numbers for the particle counts in each size range shown in the table. The “basic” class is then the highest of these individual codes. The basic class is in the first register, with the individual classes made available in the registers shown.

For these standards there is a complication in that they all define an additional class “00”. This is an extra “cleaner than class 0” class. We distinguish this from 0 using the numeric value -1. Negative numbers are represented in a Modbus register using the “twos complement” notation. If the user program interprets this as a positive number it will appear as 65535 (0xFFFF hex).

Classes range from 00(-1) to 12.

## 5.4.1.2.4 AS4059E-2

AS4059E Table 2 also has some similarities to NAS1638. In terms of the representation in Modbus registers, the main differences are an extra  $4\text{-}6\mu\text{m}_{(c)}$  size range and the addition of an extra “000” class. This is represented using the number -2. If the user program interprets this as a positive number it will appear as 65534 (0xFFFE hex).

## 5.4.1.2.5 Temperature and Water Content Measurements

These are contained in the TEMPERATURE register 33 and the RH (relative humidity) register 34. These are scaled by a factor of 100, so that values of  $12.34^{\circ}\text{C}$  and  $56.78\% \text{ RH}$  would be represented by values of 1234 and 5678 respectively. The temperature can go negative, in which case the usual “twos complement” representation is used. Most controllers should have a facility for reading “signed integers” encoded in this way (these will appear as large positive numbers if interpreted instead as positive numbers, for example 65535).

The special value -32768 (0x8000 hex) is again used to indicate “No result”, as per the contamination result codes. This could be due to a sensor failure or to the unit still in the process of powering up.

### 5.4.1.3 Performing Tests

#### 5.4.1.3.1 Commanding Test Start

If the ICM 4.0 is monitoring a single machine, it will normally be configured to test continuously and automatically, so that the contamination measurement can be read out at any time as described above. However some applications need a defined test start and test end, for example end-of-line production testing, where each result relates to a separate item being tested.

These applications can simply use a push button (or relay) wired to the ICM 4.0 start signal, or the front panel push button, or can be commanded programmatically via Modbus.

To start or restart a test, write the value 1 to the command register 21. The test duration can be set using LPA-View before installation, or alternatively write the required test time (in seconds) to the TEST DURATION register 18.

#### 5.4.1.3.2 Test Status

A test status code is available in register 30. This contains a number indicating the current state of the ICM 4.0, according to section 7.2.2, table 7A. This allows a system to remotely monitor the ICM 4.0 operation, if desired, allowing more specific diagnostics.

NOTE: the fault conditions are also indicated on the front panel LED, while “No Result” in the case of a fault is indicated using special result values as previously described.

#### 5.4.1.3.3 Test Completion

The TEST COMPLETION is indicated by register 36. This contains a number between 0 and 1000 indicating the test progress (this is also used by LPA-View to drive the test progress bar).

#### 5.4.1.4 Particle Counts

Some quantities are (or may become) too large to fit into a single 16-bit register. For example the 4µm particle count could easily be more than 65535. These items are represented using two consecutive registers; the combination makes up a 32-bit integer. For example, the value of such a 32 bit unsigned integer stored in the two registers 40 and 41 may be calculated using the formula:

$$\text{Value} = (65536 \times (\text{register } 40)) + (\text{register } 41)$$

The particle counts are stored in registers 40-55, as shown in Table 6D. There are 8 register pairs; each pair encodes one count channel as a 32 bit integer, using two consecutive Modbus registers as explained above. The Counts are per 100ml.

Particle sizes are expressed below according to ISO 4406, i.e. equivalent projected area diameter. The sizes have been chosen so that all supported coding standards (NAS, ISO...) can be derived from them. The counts are all cumulative.

# PRODUCT INSTALLATION

Differential counts can be derived by subtraction. E.g., the NAS 5-15 $\mu\text{m}$  count could be calculated by subtracting the ISO 6 $\mu\text{m}_{(c)}$  count from the 14 $\mu\text{m}_{(c)}$  count.

Number	Function	Comment
40-41	$\geq 4 \mu\text{m}_{(c)}$	-
42-43	$\geq 6 \mu\text{m}_{(c)}$	$\geq 5 \mu\text{m}$ (NAS)
44-45	$\geq 14 \mu\text{m}_{(c)}$	$\geq 15 \mu\text{m}$ (NAS)
46-47	$\geq 21 \mu\text{m}_{(c)}$	$\geq 25 \mu\text{m}$ (NAS)
48-49	$\geq 25 \mu\text{m}_{(c)}$	-
50-51	$\geq 38 \mu\text{m}_{(c)}$	$\geq 50 \mu\text{m}$ (NAS)
52-53	$\geq 50 \mu\text{m}_{(c)}$	-
54-55	$\geq 70 \mu\text{m}_{(c)}$	$\geq 100 \mu\text{m}$ (NAS)

Table 5D Particle Count Registers

## 5.4.1.5 Alarms

### 5.4.1.5.1 Alarm Mode

The ICM 4.0 includes two relay outputs that can optionally be used for signaling the state of the unit. These are normally used in “stand-alone” applications where the Modbus interface is not used (since a Modbus controller / PLC already has all the exact results available in digital form and can work with these directly.)

There are a number of preset “modes” that determine the exact function of the relays. Refer to the alarm mode section for more details (5.3.3.9.2).

These modes are normally set at installation time using our PC software package LPA-View. But it is also possible to use Modbus to set the operating mode of these relays, by writing the corresponding integer to the alarm mode register 26.

### 5.4.1.5.2 Alarm Limits

Settable Upper and Lower limits for particulate contamination are provided.

These are two groups of 8 registers representing the “Upper Limit” and “Lower Limit” for particulate contamination. These are 64-71 and 72-79 respectively.

These are expressed in terms of the result codes using the same format as in 5.4.1.2. An additional special value of 0x8000 (hexadecimal representation) is used to signify a “don’t care” setting for that limit code.

## 5.4.2 CANbus Installation

The ICM 4.0 supports the major CANbus basic message format standards CAN 2.0A (11 bit identifiers) and CAN2.0B (29 bit identifiers). J1939 and CanOpen are higher level protocols built on these basic standards. J1939 uses CAN2.0A, and CanOpen uses CAN2.0B. The ICM 4.0 does not implement either of these protocols. Instead it defines a few CANbus messages to communicate data. However the message identifiers have been chosen so as to allow operation with both J1939 and CanOpen. Generally it should be possible to use the ICM 4.0 with either, as well as other CANbus systems.

## Installation

- Perform a general installation and check of the ICM 4.0 as detailed in section 5 earlier.
- Perform a one-off general configuration check of the ICM 4.0 using a PC running LPA-View e.g. set it to test continuously and automatically start testing on power up. This procedure is described earlier in section 5. You will need a suitable RS485 interface, such as the ICM-USBi.
- Use the software to configure any CANbus specific parameters required by your CANbus network, for example configure a CANbus message ID and baud rate

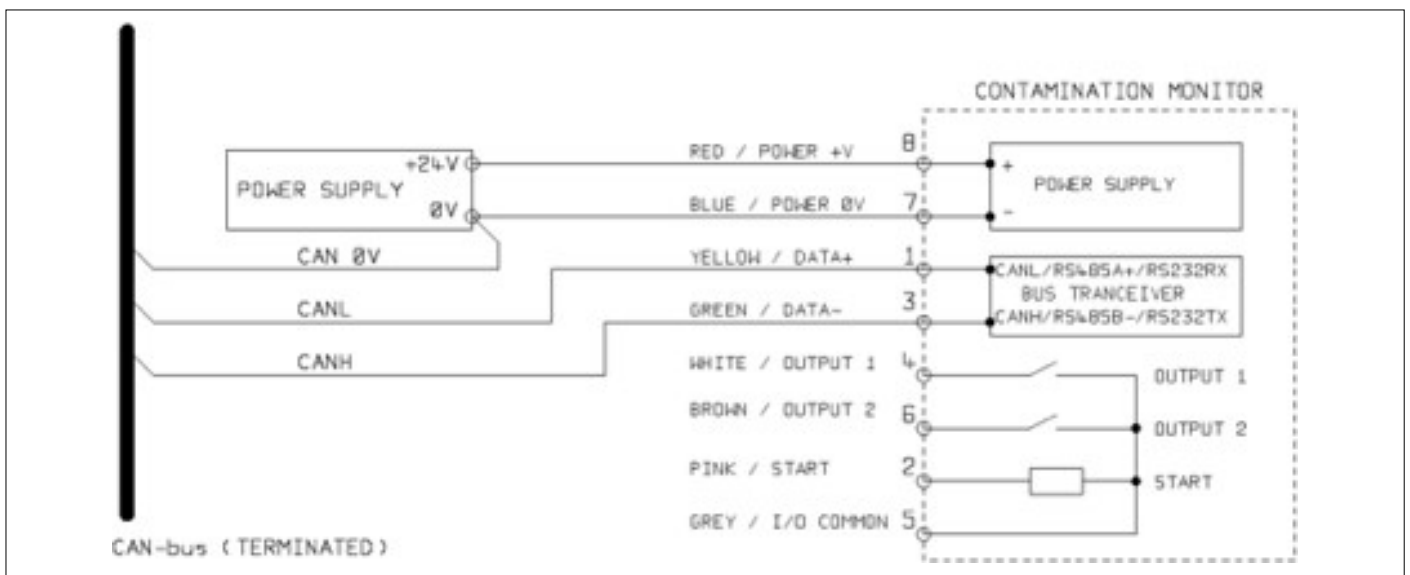

Figure 5.31

- Connect the ICM 4.0 to your CANbus network and provide a 24VDC power supply, as per figure 5.31.
- The ICM 4.0 automatically emits the test result message after each set test interval.
- Configure your CANbus controller to listen for the messages configured above.
- The ICM 4.0 requires a DC power supply and the two CANbus signals CANL and CANH, as shown in Figure 1. The numbers shown are the pin numbers of the circular connector that plugs into the ICM 4.0.
- CANbus requires the network to be terminated at each end. This must be done externally to the ICM 4.0.
- The CANbus signals CANL and CANH are referred to the system 0V supply. These should stay within the common mode range allowed by the ISO-11898-4 CANbus standard relative to the ICM 4.0 0V connection. This range is -2V to +7V. This can be normally be ensured by connecting together the ICM 4.0 0V and the 0V of the CANbus controller. The “CAN 0V” wire shown indicates this link. (Not needed if both CANbus controller and ICM 4.0 are connected to a vehicle chassis or otherwise “Earthed”).
- There are other wires available for switched alarm and start signals (optional). These are documented separately in section 5.1.2.4 and 5.1.2.5.

# PRODUCT INSTALLATION

## 5.4.2.2.1 Use PC Software for Configuration

The free LPA-View software package is needed in order to initially configure the ICM 4.0. Once configured, the unit can be left connected to the CANbus network.

The ICM 4.0 was designed to be as flexible as possible. There are large number of options for setting operating modes, test result formats, alarm settings, downloading stored data etc.

The easiest approach is to use LPA-View to configure the test parameters and result format. Then the customer application only has to read the results.

The CANbus parameters are configured from the Communication Settings dialogue, accessed from the ICM 4.0 Settings dialogue (see section 5.3.3).

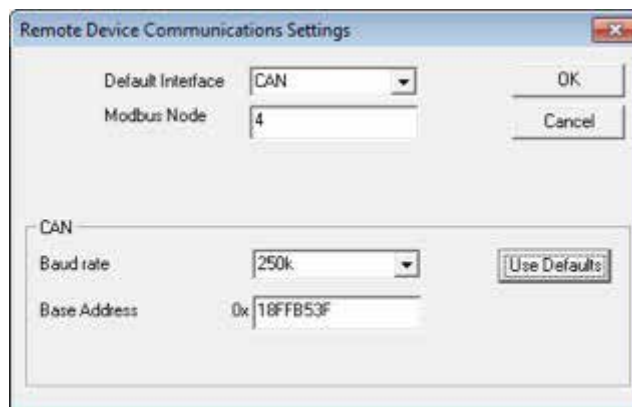

Figure 5.32 Communication Settings Dialogue

The ICM 4.0 can use either CAN 2.0A “basic” format with 11 bit identifiers, or CAN2.0B “extended frame” format with 29 bit identifiers.

### 5.4.2.2.2 CAN2.0B and J1939

The default 29 bit format is designed to be compatible with the J1939 standard. It should also be possible to use the ICM 4.0 with any system that permits arbitrary raw CANbus 2.0B identifiers to be received.

The dialogue shows the default CANbus settings. The ICM 4.0 transmits all data using a range of message identifiers starting at that selected. If the “Use Defaults” button is pressed, the program constructs an identifier suitable for J1939 (i.e. this will use PGNs within the region allocated to proprietary applications, starting at 0x00FFB53F).

At the end of each test, the ICM 4.0 will generate a “test result codes” message using the selected CANbus identifier. On a J1939 network the test result will appear as PGN 0x00ff00. Users not using J1939 can simply listen for messages with the identifier shown in the dialogue, e.g. 0x18FFB53F.

### 5.4.2.2.3 CAN2.0A and CanOpen

The 11 bit format is designed to be compatible with the CanOpen standard. It can also be used with any system that allows raw CANbus 2.0A identifiers to be received.

In order to use 11 bit identifiers (CAN 2.0A) set a value below 0x7ff for the “Base Address”.

For a CanOpen network, use a base address of 0x182 for example. This will result in message IDs corresponding to the CanOpen “pre-defined connection set”.

### 5.4.2.3.1 CANbus Settings

CANbus physical layer	ISO-11898-2
Protocol type	CAN2.0B (29 bit identifiers) CAN2.0A (11 bit identifiers)
Baud	User Set 1M/800k/500k/250k/125k/100k/50k/20k/10k
Identifier Range	User Set

### 5.4.2.3.2 Operation

Typically the installer will have configured the ICM 4.0 to automatically start continuous testing. At the end of each set test interval (e.g. 2 minutes) the ICM 4.0 will emit a CAN “Result Codes” message using the set CAN identifier (e.g. 0x18FFB53F using hexadecimal notation). So a typical CAN message might be:

	Byte							
Identifier	1	2	3	4	5	6	7	8
0x18FFB53F	12	8	2	-	-	-	-	-

### 5.4.3 Analogue 4-20mA Modes

The ICM 4.0 provides two analog 4-20mA current loop outputs, A and B. In order to provide the possibility of transmitting more than two parameters, several different modes can be chosen to suit the application.

# PRODUCT INSTALLATION

## 5.4.3.1 Fixed - NAS1638 and RH

The ICM 4.0 result format must be set to NAS1638. The outputs then simply indicate the NAS1638 contamination class and the RH level as follows:

Output A	Contamination Code =mA-5	4mA NAS 00 5mA NAS 0 6mA NAS 1 ... 17mA NAS 12 20mA OVERRANGE
Output B	RH% =(mA-4)*100/16	4mA 0% RH 5mA 6.25% RH 20mA 100% RH

## 5.4.3.2 Time Multiplexed Schemes

These output the result parameters on a single output (A) in a timed sequence. This mode would be used to read the result parameters in to a PLC. The PLC would need to be programmed to read each parameter at the correct time.

These modes are still under development; please contact MP Filtri UK for details.

- We output a current <5mA (4.0mA) for 1 second to indicate start of “frame”, this is denoted by <SYNC> in the following examples. The PLC needs to continuously check for this condition so that it can start the timer sequence for acquiring the results.
- Parameters are output in a sequence, one parameter per second until the end of the list.
- We use an “out of range” current of >20mA (24mA) to indicate parameter not available.
- The sequence is then repeated

### RH Coding

The RH value is encoded according to the formula:

$$\text{mA} = 6 + (\text{RH}\% / 10)$$

or

$$\text{RH}\% = (\text{mA} - 6) * 10$$

So 0% RH =6mA, 100% RH =16mA (max legal measurement value), unavailable = 24mA

### Temperature Coding

The temperature in degrees C is encoded according to the formula:

$$\text{mA} = 10 + (^\circ\text{C} / 10)$$

or

$$^\circ\text{C} = (\text{mA} - 10) * 10$$

NAS1638, AS4059E1, ISO 11218

Parameters are output in the sequence:

<SYNC> <CLASS> <CLASS 5-15um> <CLASS 15-25um> <CLASS 25-50> <CLASS 50-100> <CLASS 100+> <RH> <TEMP>  
<...>

These contamination classes are encoded as:

Class = mA -7

For example: Class 00 = 6mA, Class 0 = 7mA, Class 1 = 8mA, ... Class 12 = 19mA, Off scale = 20mA

ISO 4406

Parameters are output in the sequence:

<SYNC> <ISO4> <ISO6> <ISO14> <ISO21> <ISO25> <ISO38> <ISO50> <ISO70> <RH> <TEMP> <...>

ISO 4406 codes are encoded as:

$$mA = 6 + ISO / 2$$

or

$$ISO = 2 \times (mA - 6)$$

So 6mA = ISO 0, 20mA = ISO28

AS4059E2

Parameters are output in the sequence:

<SYNC> <BASIC> <A> <B> <C> <D> <E> <F> <RH> <TEMP> <...>

AS4059E2 contamination codes are encoded as:

$$mA = 6 + (code + 2) / 2$$

or

$$code = 2 \times (mA - 6) - 2 = 2 \times mA - 14$$

So that 6mA = -2 = 000, 6.5mA = -1 = 00, 7.0mA = 0, 7.5mA = 1, 13mA = 12 = max valid reading, 20 mA = over range



# PRODUCT INSTALLATION

## 5.4.3.3 Time Multiplexed Scheme 2

This outputs the parameters as currents, using values designed for viewing directly on a programmable process meter. There is no “sync” value but the final parameter stays on for 2 seconds instead of 1. To avoid confusion the RH channel does not output temperature (just static RH value). The other channel outputs just the overall contamination code value except for ISO 4406 where it cycles between 3 ISO codes.

## 5.5 Disposal

- All ICM products are sent in a cardboard box with foam inside and these should be recycled accordingly.
- Fluids used with the ICM 4.0 should be fully drained and disposed of according to EU waste framework directive and ISO44001

## 6 WiFi Installation

### 6.1 Guide to installing the WFXI Wifi extender

The WFXI Wifi extender is for customers with an ICM 2.0 only.  
The ICM 4.0 has Wifi built-in.

Download latest firmware from the MP Filtri website:  
[www.mpfiltri.co.uk](http://www.mpfiltri.co.uk)

- To install the latest firmware onto an existing ICM 2.0 you will need to be using an ICM-USBi connection, attached through connection 2 - the RS485 connector (see illustration)
- Power Cable must be repositioned into connection 1
- The ICM-WFXI can now be fitted securely into Connection 2
- Follow the standard installation for Wifi (see on next page).



Figure 6.1 Electrical port options on ICM2.0



Figure 6.2 Power cable position on ICM2.0



Figure 6.3 WFXI position on ICM2.0

# WIFI INSTALLATION

## 6.2 Connecting to Wifi (ICM 2.0 and ICM 4.0)

Make sure that the ICM is situated in a position that has adequate signal of the required Wi-Fi network.

- Power up the ICM as normal - 9-36v DC, this can be done via ICM-USBi with connection to mains supply via the adaptor or the wiring the flying leads of the supplied 3m cable to 9 - 36v. See ICM2.0 quick start guide or user guide for further details.
- Upon start up the Wi-Fi module which is integrally mounted to the ICM 4.0 or the fitted WFXi sends a Wi-Fi network signal
- To connect to this signal - open the Wi-Fi options on a phone or tablet, usually by a long hold on the Wi-Fi icon - see below circled in yellow.
- This will search for available networks
- The network should be displayed as 'MP Filtri ICM \*\*\*\*\*' usually in the format of ABC12345.

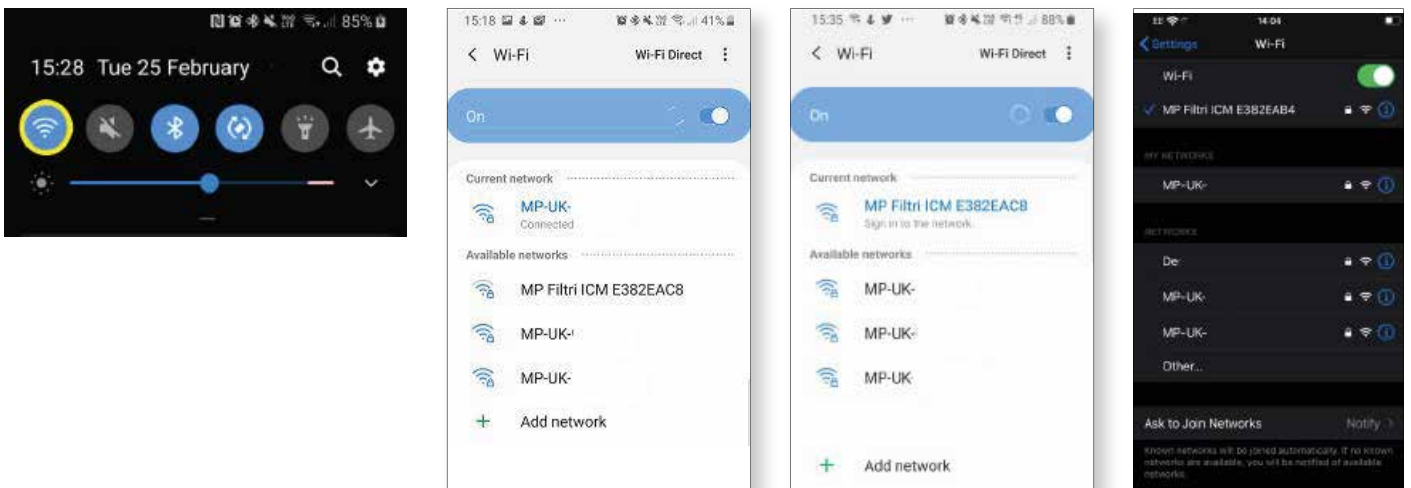

- Connect to this network, it will take you to the configure Wi-Fi setup portal - or for first time set up of a specific ICM 4.0 Wi-Fi module a password is required - password is mpfiltri , this is a one time password when setting up on a new phone/tablet and for each new ICM 4.0. Once input this will take you to the portal page.

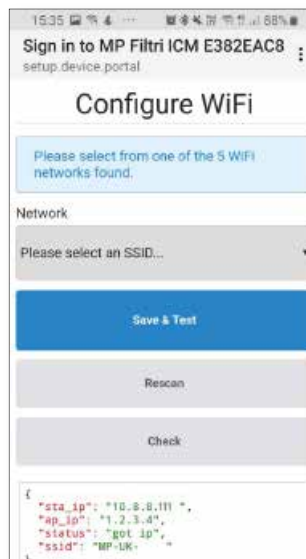
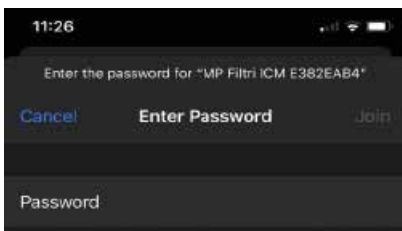

Android device



Apple device

- Chose the relevant SSID (service set identifier) network. The Wi-Fi network that the ICM 4.0 is to be connected to.
- Dependant on the setup of the selected network you may need to input the network password now.
- Press **Save & Test** this will then test the signal connection and advise if the configuration has been successful.



- The linked SSID and the assigned IP address are shown at the bottom dialogue status box
- Once an IP address is assigned the LED on the front of the ICM flashes cyan every 5 seconds.

```
{
  "sta_ip": "10.8.8.210",
  "ap_ip": "1.2.3.4",
  "status": "got ip",
  "ssid": "MP-UK-"
}
```



The ICM is now configured to the desired SSID network.

### 6.3 Communication Platforms

The various platforms on which to view/communicate with the ICM 4.0 over are now available to use.

- MP FILTRI CONNECT STATUS - Networking software for viewing numerous supported units on one platform.
- MP FILTRI CONNECT - Phone application, suitable for Android and iOS supported devices.
- Web page via IP address
- LPA-View Software - standard software that is supplied with all Contamination Monitoring Products.



# WIFI INSTALLATION

## 6.3.1 MP Filtri Connect Status

MP FILTRI CONNECT STATUS software allows the viewing of the status of each unit that is connected on a specific network.

- To Install MP FILTRI CONNECT STATUS software - insert the supplied memory stick.
- Open the WIFI - ICM 4.0 - WFXI folder
- Open the file MP\_Filtri\_Connect file - this opens the MP Filtri Connect Setup Wizard.

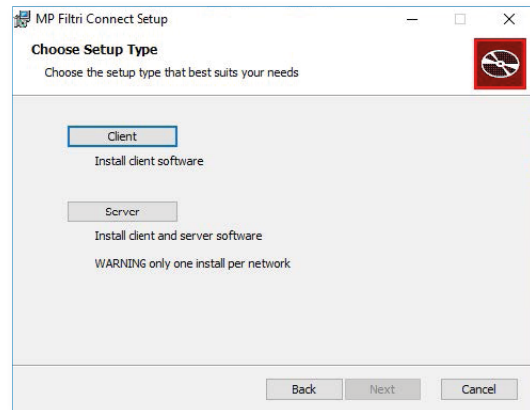
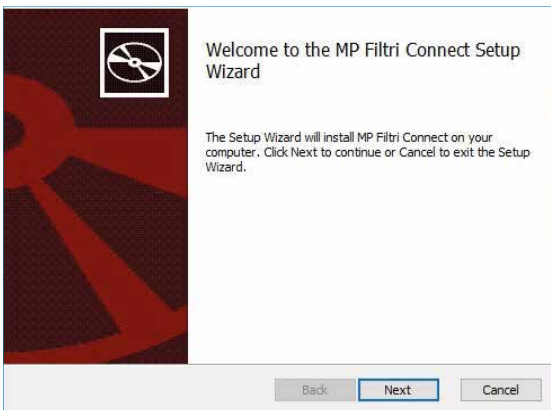

There are two options available to install on a network - the Client - this can be installed onto all computers where the status is to be viewed and the Server option - this is to be installed onto one computer only. The Client programs gather and display the information from the server install.

These Client installs along with the Server program must use or be connected to the same Wi-Fi network as the ICM 4.0.

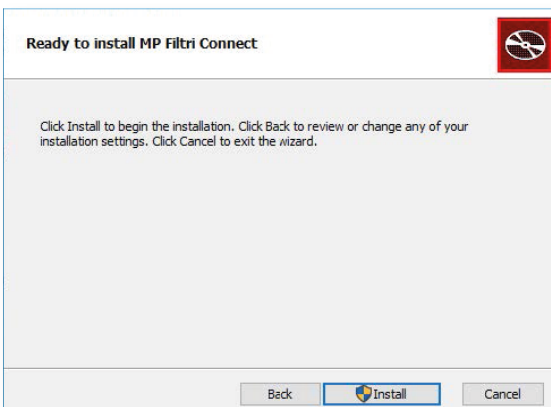

The install wizard completes the installation and pastes a shortcut onto the desktop.

The Server option installs three programmes:  
 MP FILTRI CONNECT STATUS, MP FILTRI CONNECT SIMULATOR  
 and MP FILTRI CONNECT CONSOLE.



### MP FILTRI CONNECT STATUS

Software program allows the viewing of the status of each unit on a specific network.  
 See below for further details.

### MP FILTRI CONNECT SIMULATOR

This programme allows simulation units to be added to the status software to assist in demonstration of the unit - and to check functionality. This is not normally used in day to day running of the STATUS software.

### MP FILTRI CONNECT CONSOLE

This is the programme that communicates with the ICM 4.0 Wi-Fi module and the STATUS programme, it also displays the dialogue between them and writes the results into a temporary files - these files are automatically uploaded to the LPA-View software once this is opened - or writes directly to LPA-View (see below) if already opened. This needs to be running for the STATUS programme to function correctly.

## 6.3.2 Webpage Monitoring

Webpage via IP address - the IP address can be found on the ICM 4.0 units diagnostic page - Right arrow from start up screen then scroll up/down to get to the page as shown below.

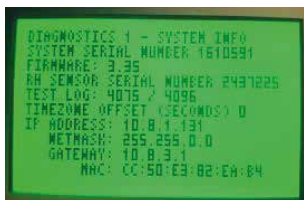

Type this IP address into a web browser (the computer or laptop must be on the same SSID network as the ICM 4.0) - this then connects to the webpage of the selected ICM 4.0 unit.

Details of the ICM and Wi-Fi firmware, the MAC address for the Wi-Fi module along with the settings of the ICM - serial number/test reference, test progress, reporting format and last completed test details, can be found.

ICM4.0 Inflow Contamination Monitor	
ICM Firmware:	3.35
WiFi Firmware:	0.17
Cloud ID:	MP_ICM_ARC12554
MAC Address:	2462AR032554
Uptime:	11231s
RAM:	Free 196000 / 1WM 172150
Filesystem Free:	1680947
IP:	10.8.1.118
SSID:	MP-UK-Data
---	
SETTINGS:	
Modbus/Canbus Node:	4
Test Time (s):	300
Test Interval (s):	0
Serial Number:	666
Test Reference:	ICM4.0 MP Filtr
Test Progress:	
Reporting Format:	ISO1406
Contamination:	14/12/10
Counts	
$\mu\text{m}(c) / 100\text{ml}$	
>4	8191
>6	2047
>14	511
>21	127
>25	31
>38	7
>50	1
>70	0



# WIFI INSTALLATION

## 6.3.3 LPA-View Software

LPA-View software - The general software that is supplied with all contamination monitoring products (CMP).

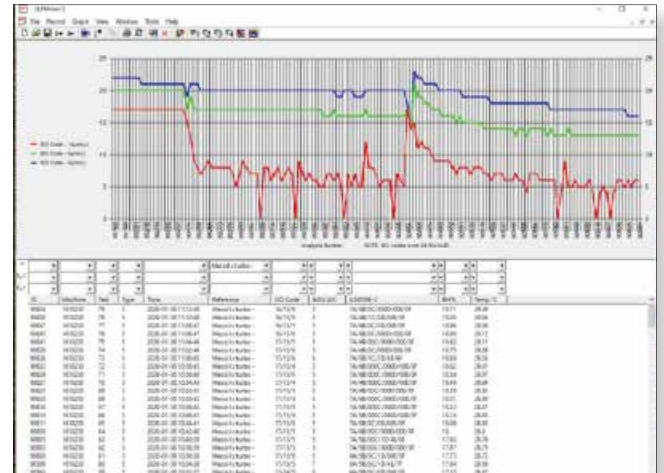

## 6.3.4 MP Filtri Connect Programs

### 6.3.4.1 MP Filtri Connect Console

This is the programme that communicates with the ICM 4.0 Wi-Fi module and the STATUS programme, it also displays the dialogue between them and writes the results into a temporary files - these files are automatically uploaded to the LPA-View software once this is opened - or writes directly to LPA-View (see below) if already opened.

This needs to be running for the STATUS programme to function correctly.

It logs, time and date of communication and completed tests of the ICM 4.0 see below dialogue box for an example.

These test results are automatically logged into a temporary file on the computer and uploaded to LPA-View once this software is running.

See ICM2.0 user guide for further details.

```

MP Filtri Connect Console
RunType: FromConsole
Directory: C:\Program Files (x86)\MP Filtri UK Ltd\connect
MSD TCP Discovery: No Devices(5)
11/02/2020 10:20:12 Info : Create message box
11/02/2020 10:20:15 Info : Start components
11/02/2020 10:20:15 Debug : Setup IIC: 00000000-0000-0000-0000-000000000000
11/02/2020 10:20:15 Info : Upload discovery listening on ICM port 60000
11/02/2020 10:20:15 Info : Status configuration port 50007
11/02/2020 10:20:15 Info : Upload listening on port 50007
11/02/2020 10:20:15 Debug : Connection for ICM discovery Connected
11/02/2020 10:20:15 Debug : Connection for Network UDP discovery Port 50000 Connected
11/02/2020 10:20:15 Info : Liveupdate listening on port 50004
11/02/2020 10:20:15 Info : Status listening on port 50007
11/02/2020 10:20:15 Debug : PRO/CP processor received test message: I'm alive
11/02/2020 10:20:15 Debug : Network discovery processor received test message: I'm alive
11/02/2020 10:20:15 Debug : Upload discovery processor received test message: I'm alive
11/02/2020 10:20:15 Debug : CMPService processor received test message: I'm alive
11/02/2020 10:20:15 Debug : ICM processor received test message: I'm alive
11/02/2020 10:20:15 Debug : Upload processor received test message: I'm alive
11/02/2020 10:20:15 Debug : Liveupdate processor received test message: I'm alive
11/02/2020 10:20:15 Debug : Status Controller received test message: I'm alive
11/02/2020 10:20:15 Debug : Connection to CMP Service Connected
11/02/2020 10:20:15 Debug : Database processor received test message: I'm alive
11/02/2020 10:20:15 Debug : Using IIC Ethernet
11/02/2020 10:20:15 Debug : Using IIC Ethernet 4
11/02/2020 10:20:15 Debug : Connection for ICP discovery Connected
11/02/2020 10:20:15 Debug : Hardware Discovery Controller discovered device : CC00010000000000000000000000000000
11/02/2020 10:20:18 Debug : IP: 192.168.1.131/204 (192) : requesting download
    
```

```

MP Filtri Connect Console
15/02/2020 11:31:04 Debug : New Test 1956 From Device 1026092
15/02/2020 11:31:04 Debug : New Test 1957 From Device 1026092
15/02/2020 11:31:04 Debug : New Test 1958 From Device 1026092
15/02/2020 11:31:04 Debug : New Test 1959 From Device 1026092
15/02/2020 11:31:04 Debug : New Test 1960 From Device 1026092
15/02/2020 11:31:04 Debug : New Test 1961 From Device 1026092
15/02/2020 11:31:04 Debug : New Test 1962 From Device 1026092
15/02/2020 11:31:04 Debug : New Test 1963 From Device 1026092
15/02/2020 11:31:04 Debug : New Test 1964 From Device 1026092
15/02/2020 11:31:04 Debug : New Test 1965 From Device 1026092
15/02/2020 11:31:04 Debug : New Test 1966 From Device 1026092
15/02/2020 11:31:04 Debug : New Test 1967 From Device 1026092
15/02/2020 11:31:04 Debug : New Test 1968 From Device 1026092
15/02/2020 11:31:04 Debug : New Test 1969 From Device 1026092
15/02/2020 11:31:04 Debug : New Test 1970 From Device 1026092
15/02/2020 11:31:04 Debug : New Test 1971 From Device 1026092
15/02/2020 11:31:04 Debug : New Test 1972 From Device 1026092
15/02/2020 11:31:04 Debug : New Test 1973 From Device 1026092
15/02/2020 11:31:04 Debug : New Test 1974 From Device 1026092
15/02/2020 11:31:04 Debug : New Test 1975 From Device 1026092
15/02/2020 11:31:04 Debug : New Test 1976 From Device 1026092
15/02/2020 11:31:04 Debug : New Test 1977 From Device 1026092
15/02/2020 11:31:04 Debug : New Test 1978 From Device 1026092
15/02/2020 11:31:04 Debug : New Test 1979 From Device 1026092
15/02/2020 11:31:04 Debug : New Test 1980 From Device 1026092
15/02/2020 11:31:04 Debug : New Test 1981 From Device 1026092
15/02/2020 11:31:04 Debug : New Test 1982 From Device 1026092
15/02/2020 11:31:04 Debug : New Test 1983 From Device 1026092
15/02/2020 11:31:04 Debug : New Test 1984 From Device 1026092
15/02/2020 11:31:04 Debug : New Test 1985 From Device 1026092
    
```

### 6.3.4.2 MP Filtri Connect Status

Once installed click onto the shortcut as shown above. This opens the status window - see below. This detects the server and devices running on the server taking this information from MP Filtri Connect Console program which must be running as well.



There are drop-down expansions to the interface - click on the arrows on the left hand side to expand the settings options - where tick boxes are used for the display options, once any changes are made click the APPLY button on the right hand side - this will save the selected options.

Each unit that has communicated with the console program will be shown on the connect status window, whether connected or disconnected - until the program is closed.

The previous/live tests can be viewed by clicking on the left-hand side arrow next to the device which expands the view. The last 200 tests are stored here - for older test results use LPA-View Software.

To open the web information page press the Browse button at the end of the device details line, or alternatively input the IP address of the specific ICM 4.0 device directly into a web browser. This must be using the same Wi-Fi network as the device.

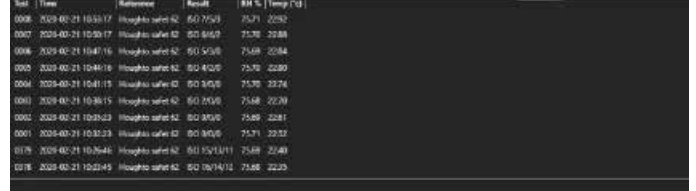
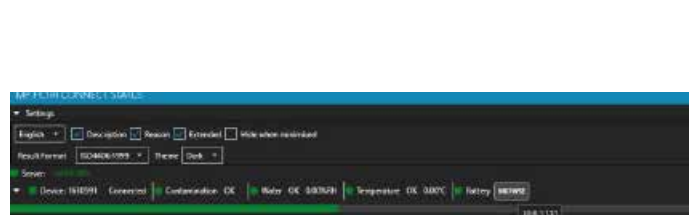
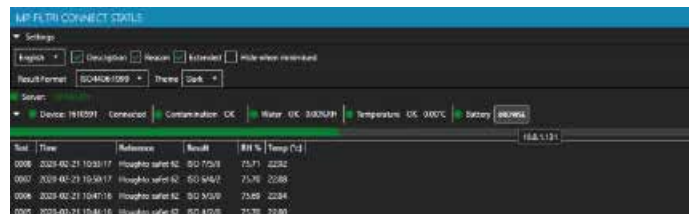
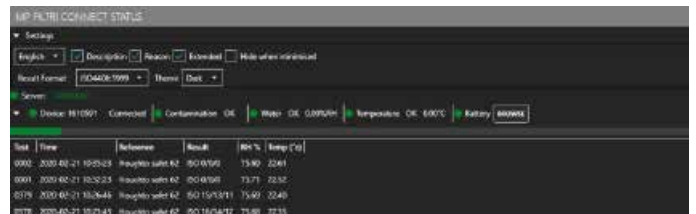
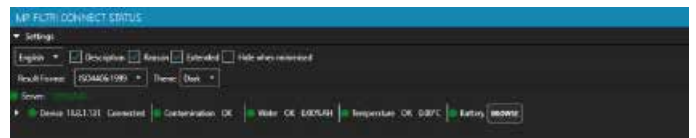



# WIFI INSTALLATION

The web information page gives general details on the unit and the last completed tests. Click on details to expand the information available - this includes details on

1. The installed ICM firmware version
2. The Installed Wi-Fi firmware
3. Cloud ID
4. Mac address
5. IP Address
6. Current connected SSID network
7. Modbus/canbus node address of the ICM 4.0
8. Test time the ICM 4.0 is set to
9. The set test interval time

### 6.3.4.3 Mobile MP Filtri Connect App



**MP Filtri Connect**  
 MP Filtri UK Ltd • Productivity  
 Installed

The mobile application is available on Google Play and the App Store.



Install the CMP-Mobile App in the normal way. The app is currently being updated and renamed to MP Filtri Connect. Once installed open the application.

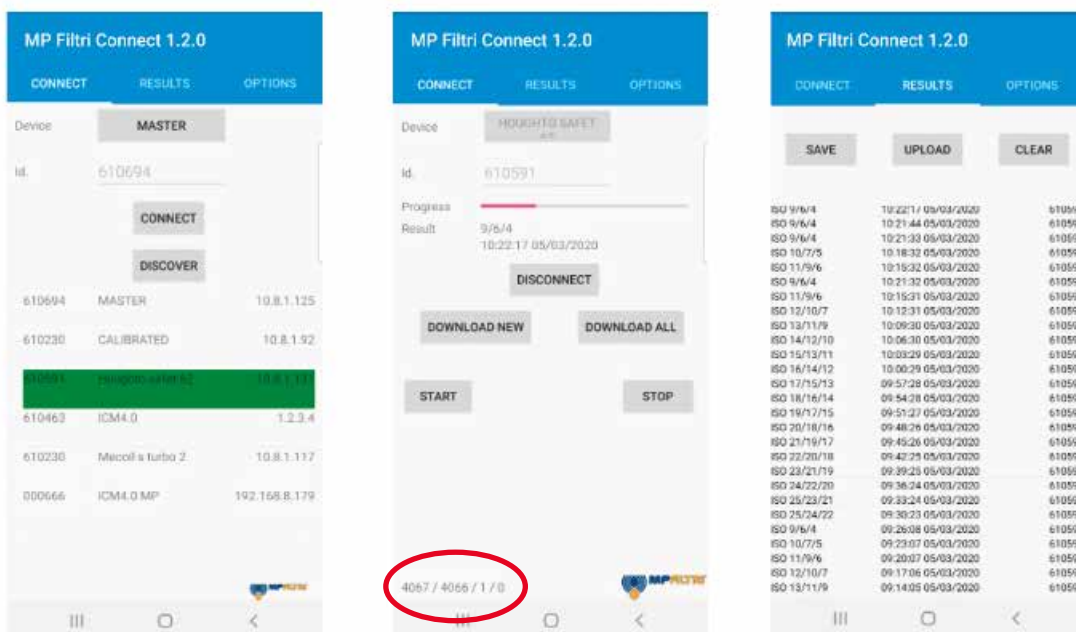

## 6.4 Discover button

This will discover all available units connected to a specific wifi network.  
Once a unit is discovered it will be highlighted in green - press on this or press connect button.

### 6.4.1 Connect Page

There are various functions that can be performed:

**Disconnect** - Disconnect from the current ICM and return to the home page.

**Download new** - Download all previously non downloaded tests from the ICM.

**Download All** - Downloads all tests in the memory of the ICM.

**Start** - Starts a new test on the ICM unit.

**Stop** - Stops any current test on the ICM unit.

When download new or all buttons are pressed the download starts and can be seen scrolling in the bottom left corner of the page - see highlighted in red circle.

The Results page can be accessed by pressing on the Results tab middle of the top of the page (Android phones) or at the bottom of the page on an iOS phone. All results will be displayed here in time order and can be scrolled through.

**Save** - Saves data to phone memory. Results will not be retained when application is closed down unless they are saved.

**Upload** - Uploads the phone memory to the MP Filtri Connect Server (when the phone is on the same wifi network) Required for downloading of results to a phone from a unit that is offsite /remote site with a different wifi network then to be uploaded to the main server

**Clear** - Clears the phone memory.

The Options page is accessed by pressing the Options tab right hand side of the top of the page (Android phones) or at the bottom right hand side of the page on an iOS phone.

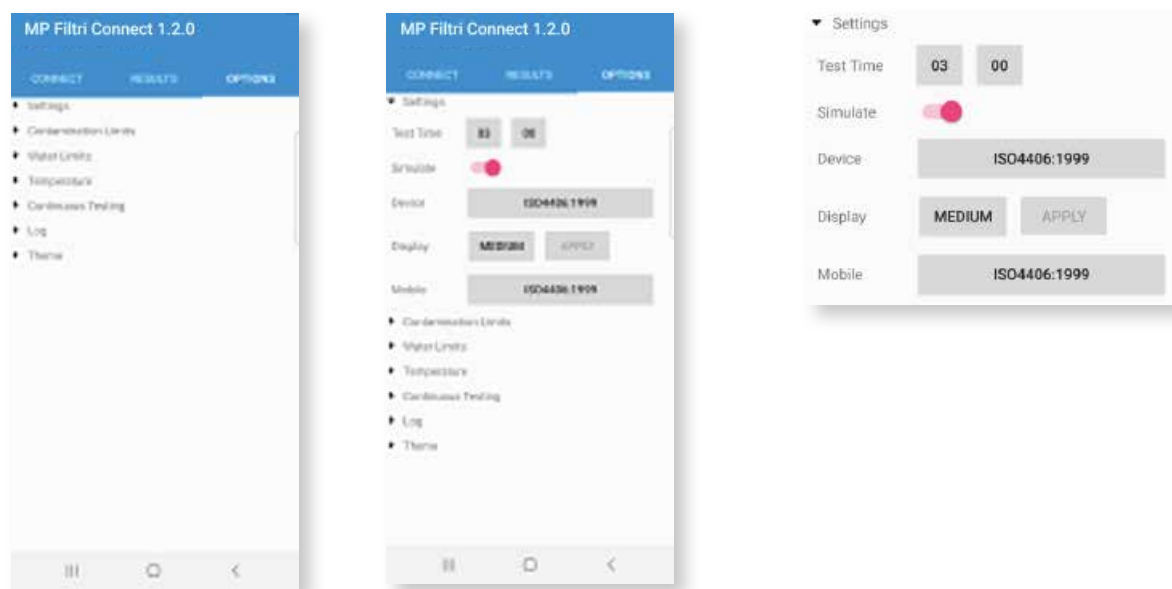

# WIFI INSTALLATION

## 6.4.2 Options Page

The options page has drop down menus on the left hand side - press on a heading to access the actions. Settings page shown above

- Test time - Changes test time on connected ICM unit
- Simulate - Toggles simulate mode on or off
- Device - The test report standard format shown on the ICM chose from all list of available standards ISO4406, NAS1638, AS4059E tables 1 & 2, AS4059F tables 1 & 2 and ISO11218
- Display - Changes the format of the test result format from short ie NAS6 to Long NAS6 (5-6-4-6-4)
- Mobile - The test report standard format shown on the phone chose from all list of available standards ISO4406, NAS1638, AS4059E tables 1 & 2, AS4059F tables 1 & 2 and ISO11218

Multi-user guideline - it is recommended that the number of users operating the phone/mobile application at any one time be kept to a minimum

## 6.5 WiFi Router

Usually the ICM 4.0 and the associated CMP-View software packages will use an existing customer network.

However below gives an example of how to setup a wi-fi router device. It may be useful for demonstrations and evaluations where an existing network is not easily available for this.

*Note: The GL-MT300N-V2 router used here is a very small inexpensive travel router, it has limited range and may not be the best choice for a permanent factory installation*



*This is an example router. Not for sale.*

### 6.5.1 Router Initial Setup Procedure

For demonstration use (where security is not a concern) there is no particular setup required other than plugging it in. The default network and password can be used.

- On the back of the router is a label with the information needed for access.
- Power up the router using the included micro USB cable. This can be connected to a computer USB port, charger port or any USB charger plug etc. This cable is not used for data, just to provide power to the router.
- The router will broadcast a network with a name (called an “SSID”) looking like “GL-MT300N-V2-XXX”. This name is also written on the routers label.
- It should be possible to connect computers, phones and ICM 4.0 hardware to this new network using the credentials given on the sticker (e.g. password “goodlife”).
- If demonstrating an ETHi board this could be plugged into the LAN socket.

## Technical Support

For further information please visit our website [mpfiltri.com](http://mpfiltri.com) or [mpfiltri.co.uk](http://mpfiltri.co.uk). For further questions email: [technical@mpfiltri.co.uk](mailto:technical@mpfiltri.co.uk)

## 7 Related Products

### 7.1 ICMRDU 2.0

The optional ICMRDU 2.0 is a separate accessory product allowing control of an ICM 4.0 that is typically inaccessible via the keypad, display and USB download.

The sensor itself is mounted remotely in another unit (normally a non-screened version). This allows the operator full control of the ICM 4.0.

The ICMRDU 2.0 connects “in between” the incoming supply/serial connections, and the ICM 4.0 sensor. It is “transparent” to the serial communications. This means that a PLC or LPA-View can operate in the usual way to control the ICM 4.0, change settings or download results, without having to unplug the RDU.

Similar components are used for the RDU as for the normal ICM-KU option, so the same instructions apply for operation. See chapter 5.2.2.2 for more details.

The RDU wiring details are shown in figure 5.5.

Please note that the RDU cable provided must be plugged into the right hand (remote) connector of the ICM 4.0 for it to work.

Please note that the RDU only records tests whilst powered up. If tests are run without the RDU connected then they will have to be downloaded directly from the ICM 4.0.

If the ICM 4.0 connected to the RDU has a serial number lower than 1610800, then the power supply must go via the RDU. Serial numbers after 161800 can be powered either via the ICM 4.0 or RDU.

The ICMRDU 2.0 is fully backward compatible with the first revision ICM products.



# ACCESSORIES

## 7.2 ICMUSBI

The USBi is a plug and play solution for easily connecting a computer to the ICM.

It includes a USB:RS485 interface with a terminal block pre-wired with the ICM cable. An extra terminal block is provided for any customer wiring to external devices.

An external DC adapter supplied can be used to power the complete system, or if the computer is always connected during use, power can be taken directly from the USB cable.

Note: Computer should have mains power applied at all times.

Detailed installation and usage instructions are provided in the separate product user guide.



## 7.3 ICM FC1

A pressure compensated flow control valve suitable for the ICM. This may be needed if the application produces an oil flow that varies outside the upper flow range of the unit.



## 7.4 Spares

- 11.615 Course screen filter to prevent blockage
- Test Hoses Various hose lengths with M16x2 hydraulic connections on each end, compatible with all ICM fluid types
- Test Points M16x2 test points of various fitting sizes for system installation
- Check Valves Various ratings up to 7 bar and manifold, available for all ICM compatible fluid options.

# 8 Troubleshooting / FAQ

## 8.1 Misuse of Product

- The product should be connected to a power supply within the rating of the product and not wired directly to the mains.
- This product should be connected to a hydraulic line; this must not exceed the upper pressure limit of the product
- Connection hoses should never be allowed to lie along the floor when the ICM 4.0 is installed and in use.
- The operator should follow all standard operating procedures previously set at the operating location as well as the procedures required by the manufacturer.
- The ICM 4.0 is not suitable for use in an explosive environment or an ATEX zone, for this refer to the ICM AZ2.
- Over-tightening of test points/ hoses can damage threads causing the unit to fail.
- The product is designed with no moving components. Should it be used outside of its fluid viscosity specification the unit will flag a flow error and invalidate that test result.

## 8.2 Fault Finding

### 8.2.1 LED Flashing / Fault Codes

The ICM 4.0 front panel led indicates a fault by a number of white flashes, with a red background. The number of flashes indicates the fault code, the screen version will also display the fault code and function:

1. Optical - An optical fault could indicate LED failure or blockage of the optical path. Try flushing with Petroleum Ether, or return to MP Filtri UK.
2. Low Flow - The ICM 4.0 estimates the flow by measuring the transition time of the particles. The Low Flow warning indicates that the flow rate is below the minimum recommended level (A). Note that the alarm should be disabled in the settings when used on clean systems, such as flushing/cleaning rigs, where the particle count could reach 14/12/10 or lower.
3. High Flow - The flow rate is above the maximum recommended level. This will degrade the accuracy of the particle counts.
4. Logging - Fault with data logging memory.
5. Water Sensor - Fault with the water sensor.

(A) The unit will still work but may be more susceptible to errors caused by pressure fluctuations. This warning can also come on when there are no particles whatsoever detected, i.e. the fluid is totally “clean”. In this case the correct result e.g. 0/0/0 is still generated.

# TROUBLESHOOTING / FAQ

## 8.2.2 Test Status

The status is shown on the ICM 4.0 screen. This contains a number indicating the current state of the ICM 4.0, according to the table below. This allows a system to remotely monitor the ICM 4.0 operation, if desired, allowing more specific diagnostics (B).

Value	Function	Comment
0	NOT READY	Unit is powering up or there is some problem
1	READY	Unit is powering up or there is some problem
2	TESTING	Test in progress
3	WAITING	Waiting between tests (D)
128	FAULT OPTICAL	LED failure/ sensor blocked/ filled with air
129	FAULT FLOW LOW	Flow too low for reliable test (E)
130	FAULT FLOW HIGH	Flow too high for reliable test
131	FAULT LOGGING	Fault with data logging
132	FAULT WATER SENSOR	Water sensor failure

Table 8A

(B) However the fault conditions are also indicated on the front panel LED, while “No Result” in the case of a fault is indicated using special result values as previously described.

(C) User has not set tests to occur automatically.

(D) User has set a non-zero test interval.

(E) Or fluid is totally clean (no particle counts). Flow alarm can be turned off by user if this is a problem, for example cleaning rigs.

## 8.2.3 Other Faults

Unexpected results obtained from sample

- Check that the microbore pressure hose has been fully connected at both the system and ICM 4.0 ends. NOTE: removing either hose from the ICM 4.0 is not indicative of flow through the ICM 4.0 as the hose end is now at atmosphere. The pressure drop across the ICM 4.0 should be verified, 5.1.3.1 Flow rate.
- Confirm that the flow through the ICM 4.0 is within the range of the unit.
- High water / aeration levels

Remote Device dialogue not responding to buttons being pressed

- Check that correct COM port has been selected in the Remote Device dialogue.
- Check USB driver has been installed.
- Disconnect power supply to ICM 4.0 and then reconnect it.

If the ICM 4.0 has been subjected to excessive contamination and a blockage is suspected, a flush with a suitable solvent may clear the blockage.

The standard ICM 4.0 is fitted with Viton® seals, so Petroleum Ether or Iso Propyl Alcohol may be used for this purpose, in conjunction with the MP Filtri UK Bottle Sampling Unit. See flushing guidelines on supplied product USB.

## DO NOT USE ACETONE

### 8.3 Test Duration

The set Test Duration is the amount of time for which particle counts are accumulated, before the test result is updated. The default of 120 seconds is likely to be suitable for most applications. However it is possible to set other values.

A shorter time enables the unit to respond more quickly to variations in cleanliness. This may be desired in order to reduce the product test time in a production line situation.

A longer test time enables the unit to average out variations in cleanliness and produce a more stable result. This is especially true for the larger particle sizes. In clean systems there are very few of these, so a large amount of fluid needs to be sampled in order to count a statistically significant number.

Another factor is the flow rate. This can be traded off with cycle time, since a higher flow allows the same amount of fluid to be sampled in a shorter time.

“Very Clean” Systems - Longer test times / higher flows are needed.

“Normal” or “Dirty” Systems - Shorter test times or lower flows are acceptable.

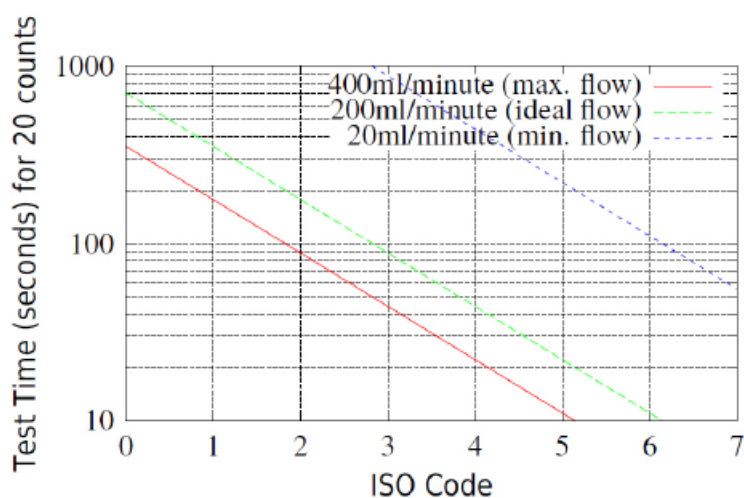

Figure 8.1 Test time needed for reliable indication by ISO code



# TROUBLESHOOTING / FAQ

## 9 Reference

### 9.1 Further Modbus Information

The ICM 4.0 is a Modbus Slave. That is, it responds only to commands sent to it by the Modbus controller (the Modbus Master). The controller can be a program running on a PC, or a PLC.

Modbus requests are sent to the configured ICM 4.0 node address. If there is only one ICM 4.0 on network segment, then the “Permanent Address” of 204 can be used. If there is more than one, then unique node addresses must be configured for each. NOTE: This is not part of the Modbus specification (and in fact violates it). The ICM 4.0 will always respond on node address 204, in addition to the other set value. This was done so that LPA-View can connect directly without configuration or scanning of the network.

The Master periodically sends a Modbus command “frame” to the ICM 4.0 node address. The ICM 4.0 acknowledges each request with a response frame.

#### 9.1.1 Modbus Registers

The Modbus protocol defines many types of information interchange commands (“function codes”). However in order to simplify implementation the ICM 4.0 only uses one type - the Modbus “Register”. Conceptually the ICM 4.0 appears as a collection of Modbus Registers. Each register is numbered - the ICM 4.0 has 125 registers.

Each register holds a number representing some quantity. For example, register number 2 holds a number indicating the ICM 4.0 software revision.

##### 9.1.1.1 Register Numbering

Addresses shown here are those appearing “on the wire”. Unfortunately some Modbus controllers may translate these addresses to different ones. For example for some controllers the user will need to use “addresses” starting at 40000 instead of 0.

The ICM 4.0 uses the registers from 0-124 (this allows all registers to fit in a single Modbus frame). Registers can be divided into classes as follows:

**Status Registers** - these are ‘read only’ registers that indicate test results and ICM 4.0 status. They can be read freely at any time (although test results are only valid after a successful test).

**Setting Registers** - these are read-write registers used to hold the ICM 4.0 settings. Take care not to inadvertently write to any of these registers since the ICM 4.0 settings will be altered!

**Calibration Registers** - Some registers, not documented here, are protected settings that can only be altered during factory calibration.

# REFERENCE

Number	Function	Units	Representation
0	Product ID	-	Unsigned integer
1	Protocol ID	-	Unsigned integer
2	Firmware Version	x100	Unsigned integer
3	Hardware options	-	Bitmap
4-5	Machine Serial Number	-	32 bit unsigned integer
6	Modbus Address	-	Integer
7	Ignore Initial N	-	Unsigned integer
8-9	Test Number	-	32 bit integer
10-17	Test Reference	-	Array of 16 packed characters
18	Test Duration	-	Unsigned integer
19	Test Format	-	-
20	Test Mode	-	-
21	Command	-	Unsigned integer
22-23	Test Interval	S	Unsigned 32 bit integer
24-25	Date/Time	Date	Unsigned 32 bit integer
26	Alarm Mode	-	Unsigned integer
27	Reserved	-	-
28	Faults	-	-
29	Reserved	-	-
30	Status	-	Unsigned integer
31	Status Flags	-	-
32	LED Level	-	Unsigned integer
33	Temperature	°C x100	-
34	RH	% x100	-
35	Peak Pulse	-	Unsigned integer
36	Test Completion	-	Unsigned integer
37	Flow Indication	-	-
38-39	Reserved	-	-
40-55	Particle Counts	-	-
56-63	Result Codes	-	-
64-71	Contamination Limit Upper	-	-
72-79	Contamination Limit Lower	-	-
80	Limit Water Upper	% x100	signed integer
81	Limit Water Lower	% x100	signed integer
82	Limit Temperature Upper	°C x100	signed integer
83	Limit Temperature Lower	°C x100	signed integer
84-85	Log Interval	Seconds	Unsigned 32 bit integer
86-87	Last Download	Date	Unsigned 32 bit integer
88	Language	-	Unsigned integer
89-116	Reserved	-	-
117-118	Calibration Due	Date	Unsigned 32 bit integer
119-120	Calibration Last	Date	Unsigned 32 bit integer
121	Reserved	-	-
122	Calibration LED Level Last	-	-
123	Calibration LED Level Initial	-	-
124	Reserved	-	-

Table 9A Modbus Register Map

### 9.1.1.2 Representations

**Modbus Registers** - All quantities are represented using Modbus registers. Modbus registers are 16 bit (0-65535 decimal or 0-0xFFFF in hexadecimal notation).

**Unsigned Integers** - These are simply single Modbus registers. Each can take values from 0 to 65535. They may be simple numeric quantities such as “test time in seconds”. They can also be enumerations such as “result format” where “0” means ISO 4406, “1” means NAS1638 etc.

**Signed Integers** - These are used for quantities that may become negative, such as °C. They are also used for result codes using formats similar to NAS1638, where we have to represent the NAS “00” class as -1, and “000” as -2. Signed integers are represented in single Modbus registers using the “twos complement” standard, as usual in computing. If a user-written program incorrectly interprets a signed integer as unsigned, then positive numbers will still be interpreted correctly. However, small negative numbers will appear as large positive ones. In particular, -1 appears as 65535 and -2 as 65534. These might be seen when interpreting the NAS codes mentioned above.

Take care when writing software dealing with NAS codes or Temperature measurements.

**32 Bit Unsigned Integers** - Some quantities are (or may become) too large to fit into a single 16-bit register. For example the Test Number could eventually increment to more than 65535. These items are represented using two consecutive registers; the combination makes up a 32-bit integer. For example, the value of such a 32 bit unsigned integer stored in registers 8-9 may be calculated using the formula:

$$\text{Value} = (65536 \times (\text{register } 8)) + (\text{register } 9)$$

**Bitmaps** - Bitmaps are again single 16-bit Modbus registers, but they have a special interpretation. Each “bit” in the register has a separate function. The most important example is the “status flags” register (31). Each register bit encodes a separate function, for example “result valid”, “new result”, “over temperature alarm” etc. In this document bits are numbered starting with bit 0 = least significant bit.

A user programming environment such as a PLC programming system or a high level computer language will normally have functions that allow easy access of individual bit values in a register.

**Arrays** - An Array is simply a sequence of objects packed in consecutive registers. For example the “result codes” are in an array of 8 registers. Code [0] is in register 56, code[1] is in register 57 etc.

In the case of an array of 32-bit integers, each element itself takes up 2 registers, so there are twice as many registers used as elements in the array. In the case of the particle counts array, there are 8 particle sizes counted so these are stored in  $8 \times 2 = 16$  registers.

**Packed Characters** - These are used to encode the user-settable “test reference” string, used to label each test. Characters are packed two per Modbus register. This will probably not be used in a user-written Modbus program, but in principle the test reference could be set to a different value for each test. The test reference string consists of 16 characters packed into an array of 8 consecutive registers.

**Date/Time** - A “Date” represents a calendar date and time as a 32 bit unsigned integer (it is the number of seconds since Jan 1 1970). User programs will not generally have to deal with this, but in principle they could e.g. read or set the real time clock from registers 24-25. It can be useful during development to be able to read the clock and see a continuously incrementing value of seconds.

# REFERENCE

## 9.1.1.3 Register Functions

### 9.1.1.3.1 Test Mode

Factory set value: 0

This is the “test mode”, each bit represents an option corresponding to a tick box on the ICM 4.0 settings screen (see our LPA-View software and in the ICM 4.0 manual).

Each bit of the register encodes one tick box.

The factory set mode is 0 for all bits, so all the tick boxes are turned off. You may want to turn on bit 8 (disable low flow alarm when clean) if you have a very clean system.

Bit	Function	Comment
0	CYCLE_CONTINUOUS	Continuous Testing
1	START_TEST_AUTOMATICALLY	Start Testing Automatically
2	CONTINUOUS_STOP_WHEN_CLEAN	Stop Testing When Clean
3	CONTINUOUS_LOG_EVERY_TEST	Continuous Mode: Log Every Test
4	CONTINUOUS_CONFIRM_TARGET	Repeat final test to confirm target level achieved
5	RESERVED	-
6	RESERVED	-
7	SIMULATE	Produces simulated test results
8	LOW_FLOW_CLEAN_DISABLED	Prevents spurious low flow alarms on clean systems

Table 9B Test Mode Register Bit Definitions

There is some general information about what these options do in section 5.4.

### 9.1.1.3.2 Command Register

This is register 21. It is special in that writing a number to this register does not store the number, but instead commands the ICM 4.0 to perform a function according to the number written. The main command is “START”, but the others are documented here for completeness and avoidance.

Bit	Function	Comment
1	START TEST	Start or Restart a test
2	RECALCULATE	-
3	FORCE OUTPUT 1 ON	-
4	FORCE OUTPUT 1 OFF	-
5	FORCE OUTPUT 2 ON	-
6	FORCE OUTPUT 2 OFF	-
7	TEST MODE ON	Flashes LED and exercises outputs
8	TEST MODE OFF	-
9	STOP	Abort a test in progress
10	LOG ERASE	Caution!
11	LOG SEEK END	-
12	LOG SEEK PREVIOUS	-

Table 9C Command Register

### 9.1.1.3.3 Status Register

This is read-only register 30. It contains a number (an enumeration) indicating the status of the ICM 4.0. See table 7A.

### 9.1.1.4 Bitmap Functions

#### 9.1.1.4.1 Status Flags Bitmap

This is read-only register 31. It represents the states of various items in a bitmap format.

- Bits 0-2 are so that external equipment (for example LPA-View or a PLC/MMI) can display, update and log results intelligently.
- Bits 3 and 4 can be used to monitor the test progress.
- Bits 5-10 are used to generate alarms. Depending on the selected alarm mode, they operate the alarm relay output(s). But they can also be monitored directly by a PLC/MMI program and used to drive indicators, for example.
- Bit 11 is used internally to detect that the ICM 4.0 is being controlled by Modbus (from a PLC or by LPA-View).
- Finally Bits 12-14 reflect the state of the ICM 4.0 “start signal” input and alarm output relays.

Bit	Function	Comment
0	RESULT_VALID	Current result is valid
1	RESULT_NEW	A new result is available
2	RESULT_LOG	Current result should be logged
3	TESTING	Test in progress
4	COMPLETE	Test is complete
5	ALM_HI_COUNT	High particle count alarm
6	ALM_HI_H2O	High water content alarm
7	ALM_HI_TEMP	High temperature alarm
8	ALM_LO_COUNT	Low particle count alarm
9	ALM_LO_H2O	Low water content alarm
10	ALM_LO_TEMP	Low temperature alarm
11	REMOTE_CONTROL	Unit is under remote control
12	IO_IP	Start signal input
13	IO_OP1	Alarm output 1
14	IO_OP2	Alarm output 2
15	UNUSED	Not currently used

Table 9D Status Flags

# REFERENCE

## 9.1.1.4.2 Fault Flags Bitmap

This is read-only register 28 (firmware 0.43 or higher required). It represents detected device or installation faults in a bitmap format. The faults are also available as result codes in the status register; however those are transient and may only appear briefly before a new test is started.

The fault bits here remain until the end of the next test (where they may be cleared if the fault has gone).

Bit	Function	Comment
0	OPTICAL FAULT	See table 9A
1	LOW FAULT	See table 9A
2	HIGH FAULT	See table 9A
3	DATA LOGGING	See table 9A
4	WATER SENSOR	See table 9A

## 9.1.2 Implementing Modbus

This section is for advanced users who wish to do their own programming to implement the Modbus controller. It is not needed if the users control system already has direct support for being a Modbus master. The following describes a minimal system capable of periodically reading data from the ICM 4.0; it is not intended as a general purpose Modbus implementation.

For a background to this section the implementer can review the Modbus source documents:

[http://www.modbus.org/docs/Modbus\\_over\\_serial\\_line\\_V1.pdf](http://www.modbus.org/docs/Modbus_over_serial_line_V1.pdf)  
[http://www.modbus.org/docs/Modbus\\_Application\\_Protocol\\_V1\\_1b.pdf](http://www.modbus.org/docs/Modbus_Application_Protocol_V1_1b.pdf)

In order to collect data from the ICM 4.0, the users control system needs to be able to send a Modbus command frame and receive a response frame via the RS485 signals.

A frame consists of a sequence of bytes, transmitted back-to-back over the RS485 interface.

A command frame can be generated corresponding to a Modbus “read registers” command. Using hexadecimal notation, the sequence required to return all registers would be a sequence of 8 bytes:

<0xCC> <0x04> <0x00> <0x00> <0x00> <0x7D> <0x20> <0x36>

This sequence is decoded by the ICM 4.0 as:

<0xCC> = <slave address>

<0x04> = <function code:read registers>

<0x00> <0x00> = <start register high> <start register low> (2 bytes)

<0x00> <0x7D> = <number of registers high> <number of registers low> (2 bytes)

<0x20> <0x36> = <checksum high> <checksum low> (2 bytes)

The ICM 4.0 will then return a 255 byte long response frame containing the requested register contents.

This 255 byte response frame looks like:

<0xCC> <0x04> <0xfa> <250 bytes of data> <2 bytes of checksum>

The <250 bytes of data> contains the contents of the 125 registers requested. Each 16 bit register is encoded in two sequential bytes, in high-low (“big-endian”) order.

The simplest method is then to read the required registers directly out of the data area of this response frame. For example, the ICM 4.0 product ID code appears in Modbus register 0. This would therefore appear in the first two bytes of the data area above, or at the 4th and 5th bytes counting from the start of the frame. In a programming language like “C” the product ID could be extracted from an array containing the frame using a statement like:

```
unsigned product_id = 256*buf[3+0] + buf[3+1];
```

Users of PLCs or other programming languages will hopefully be able to translate using the information provided here.

The ICM 4.0 product ID is 0xD3DD (hexadecimal) or 54237 (decimal). This fact can be used as a check when attempting the above implementation.

Finally we come to extracting the test result. Referring to the ICM 4.0 Modbus register map, the test result codes appear in registers 56-63. In the case of NAS1638, the overall NAS code is in register 56. So a program can extract the overall NAS code from the result frame using logic equivalent to the “C” language expression:

```
unsigned NAS = 256*buf[3 + 56*2 + 0] + buf[3 + 56*2 + 1]
```

This is a statement in the “C” programming language that reads the 116th and 117th bytes of the response frame, and forms a 16 bit number from these two 8 bit bytes. This reads modbus register 56, the NAS code.

Similar expressions can be used to read the other registers according to the data required.

For PLC users the details will be dependent on their own programming environment and facilities. But hopefully the above can be used as a guide for their own implementation.

## 9.2 Further CANbus Information

### 9.2.1 Example Walkthrough

Real applications will generally have an existing CAN network, but in this chapter we show how the ICM 4.0 can be connected to a PC using a USB:CAN adaptor.

The adaptor used in this example is the “PCAN-USB”, available from Peak System Technik GmbH or a distributor.



# REFERENCE

We also need to make up a special cable to connect this to the ICM 4.0.



Figure 9.1 PCAN-USB CANbus to USB Adaptor

## 9.2.1.1 Equipment Required

- ICM 4.0 with CANbus capability
- PCAN-USB USB:CAN Adaptor
- ICM-USBi interface for initial ICM 4.0 setup
- PC with USB ports running Windows
- Special made-up CANbus cable detailed below
- 12 or 24 Volt DC power supply

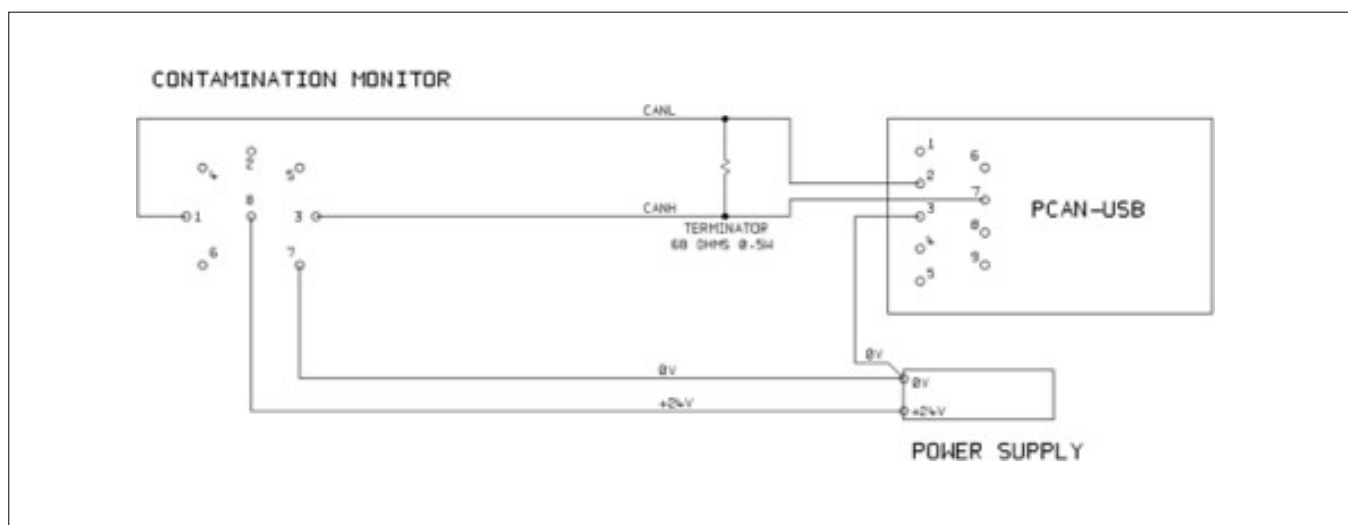

Figure 9.2 Connecting the ICM 4.0 to the PCAN-USB Adaptor

The “TERMINATOR” resistor shown simulates the combined effect of the bus termination resistors normally used on either end of a CANbus network. It’s value is not critical, anything from 50-150 ohms will work.

## 9.2.1.2 Initial Configuration

Initially we connect using the ICM-USBi interface so that the ICM 4.0 can be comfortably configured using LPA-View. Detailed information is provided earlier in the user guides but the general procedure is:

- Install LPA-View
- Plug in the ICM-USBi
- The “Hardware Found” wizard will appear. If you have an Internet connection you can let Windows Update install the driver, otherwise point the wizard to the drivers provided.
- Plug the ICM 4.0 into the ICM-USBi
- Start LPA-View
- Select Tools/Remote Control to connect to the ICM 4.0.

### 9.2.1.2.1 Suggested General Settings

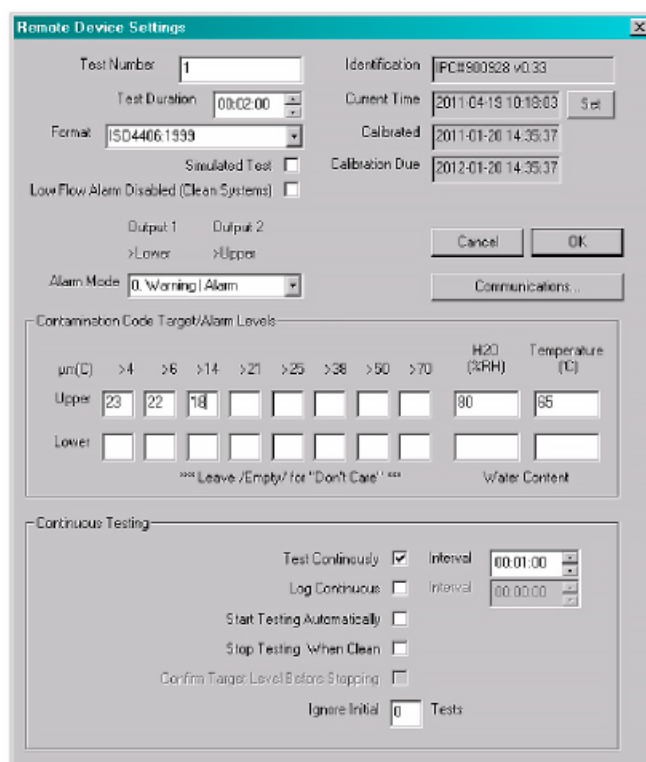

Figure 9.3 General Settings

Press the Settings button to open the Settings dialogue. The important settings for this walk-through are:

- Test Duration; 10 seconds
- Test Continuously: On, interval 0.
- Start Testing Automatically: On
- Stop Testing When Clean: Off
- Simulate Test: On

NOTE: Simulate Test will cause fictitious test results to be generated in order to test communications and demonstrate the unit. Do not forget to turn this off before deploying in a real application!

# REFERENCE

## 9.2.1.2.2 Suggested Communication Settings

Press the “Communications...” button to open the Communications dialogue. See figure 9.4.

Select the Interface, Node Number and Baud Rate as shown, then press “Use Defaults” to assign the “base address”. This will define the start of the block of CAN message identifiers used by the software (using a value compatible with the J1939 standard).

Press the OK button on the “Communications Settings” and “Remote Device Settings” dialogues. Leave the Remote Control dialogue open.

Now check that the ICM 4.0 is now set to automatically perform tests:

- Unplug the ICM 4.0 circular connector
- Plug it back in
- You should see the connection re-established on the Remote Control dialogue within a few seconds.
- A test should have been automatically started
- The tests should repeat every 10 seconds
- You should see a test result that starts high and decreases with each further test.

Close the Remote Control dialogue and quit the program. Unplug the ICM 4.0 at the circular connector.

## 9.2.1.3 PCAN-USB Software

The PCAN-USB adaptor comes with a software CD. This includes a simple CANbus diagnostic utility called “PCAN-View USB”. This should be installed from the CD.

Connect the ICM 4.0 to the computer using the special made-up cable and the PCAN-USB. Power-up the ICM 4.0 by turning on the power supply.

Upon connecting the PCAN-USB and starting PCAN-View, the Connect dialogue is presented.

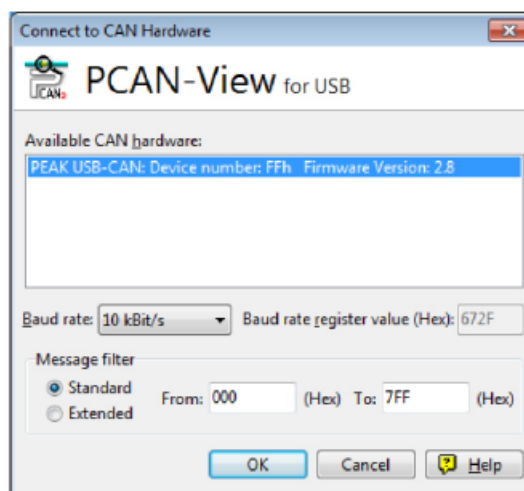

Figure 9.4 PCAN-View Connect Dialogue

Select a baud rate to match that being used on the ICM 4.0, for example 250k. Select the “Extended” message filter (so that 29 bit identifiers are used). Press OK to go to the main PCAN-View screen.

### 9.2.1.3.1 Simulated Tests

Plug the ICM 4.0 into its circular connector. It should power up and start performing a test. If everything is working, after about 20 seconds you should see CAN messages similar to that shown below. This shows the 2nd result received. The first 3 bytes 0x17, 0x15, 0x13 show the 3 ISO codes (the display is in hexadecimal (base16) so the actual code is 23/21/19).

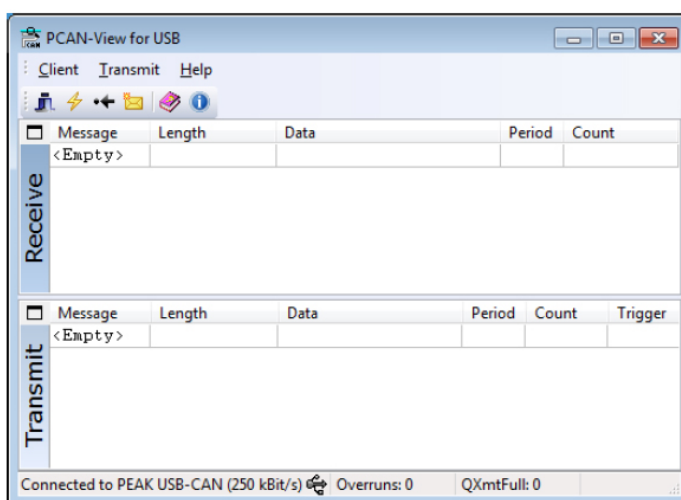

Figure 9.5 PCAN-View Main Screen

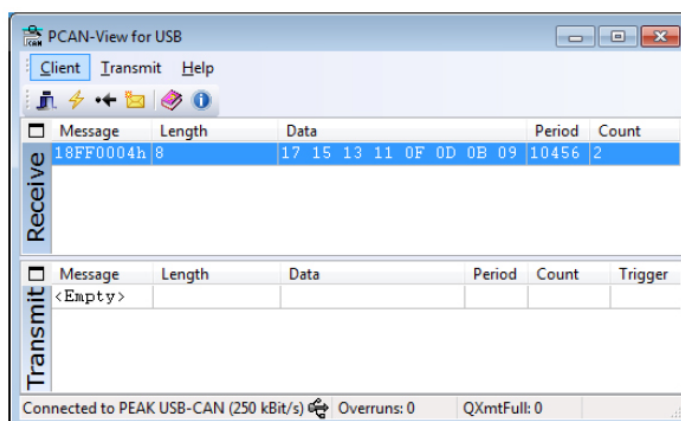

Figure 9.6 Reception of a Test Result Codes Message

## 9.2.2 Messages

### 9.2.2.1 CAN2.0B and J1939

The ICM 4.0 CANbus implementation is designed to be interoperable with J1939 networks. This is done by restricting CANbus message IDs to those within the proprietary ranges allocated by J1939. Advanced J1939 features have been avoided, so that customers not using J1939 will also be able to communicate using “generic” CANbus frames. For non-J1939 users the only requirement is that their network should support CAN2.0 (29 bit identifiers).

Broadcast messages use the J1939 PDU2 format. These are transmitted periodically to communicate the ICM 4.0 status and the latest test results.

# REFERENCE

Peer-to-peer messages use the J1939 PDU1 format. These are used to control the ICM 4.0. These are generally optional; customers may opt to leave the ICM 4.0 automatically testing and broadcasting results.

Node Address (PDU1)	0x3F (J1939 "Oil Sensor")
Command & Configuration Message PGN	0xEF3F
Broadcast Messages PGNs	0xFFB5 - 0xFFB9
Default Broadcast Interval	1s
Data Page	0
Priority	6
PDU Format/ PDU specific	Derived from PGN
Byte Endianness	All data is on little-endian byte order

Table 9F CANbus Parameters for J1939 Interoperation

## 9.2.2.2 Non-J1939 CAN2.0B Users

- Taken together these imply a generic CAN "base address" of 0x18FFB53F.
- Command and control messages can then be sent to CAN address 0x18EF3F00.

## 9.2.2.3 CAN2.0A and CanOpen

On CanOpen networks the results need to be transmitted as "process data objects" (PDOs) from the "predefined connection set". In order to do this, ensure that the set base address is equal to (0x180 + node number). For example, 0x182 to make the ICM 4.0 node address 2.

## 9.2.2.4 CANbus Message List

The message ID numbers shown are examples only and are dependent on the set base address.

For CAN2.0A/CanOpen we have an example base address of 0x182. So you see "2" as the last digit of the entire message IDs. CanOpen interprets this as the device node number. For CAN2.0B/J1939 we have an example base address of 0x18FFB53F. The equivalent node number is "3F" so you see this appear in all the message IDs. For other node numbers change the set base address value as required. CanOpen has node numbers from 0x01 to 0x7f. J1939 has node numbers from 0x01 to 0xff.

Parameter Name	CAN2.0A ID	CanOpen PDO	CAN2.0B ID	J1939 PGN
Result Codes	0x182	Transmit PDO 1	0x18FFB53F	0xFFB5
Status	0x282	Transmit PDO 2	0x18FFB63F	0xFFB6
Water Sensor	0x382	Transmit PDO 3	0x18FFB73F	0xFFB7
Commands	0x202	Receive PDO 1	0x18EF3F00	PDU1

Table 9G CANbus Messages

### 9.2.2.4.1 Message: Result Codes

This message is transmitted after each test.

The test result is expressed as a set of codes in the selected Test Format (ISO 4406, NAS1638 etc.). The test result message is always 8 bytes long, with the result codes packed as follows:

Format:Byte	ISO 4406 Code	AS4059E Table 2 Class	NAS1638/ AS4059E Table 1/ ISO 11218 (Draft) Codes/ Classes
1	≥4μ	Basic	Basic
2	≥6μ	-	-
3	≥14μ	A	5-15 μm
4	≥21μ	B	15-25 μm
5	≥25μ	C	25-50 μm
6	≥38μ	D	50-100 μm
7	≥50μ	E	>100 μm
8	≥70μ	F	-

NOTE: The 'basic' class is the highest of the individual size classes.

ISO 4406 only defines codes for the first 3 sizes 4, 6 and 14 μm. we extend the concept to cover the other sizes. This allows limits to be set on the number of large particles, even when using the ISO 4406 coding system.

#### 9.2.2.4.1.1 Special Values

The result codes use a few "special" values in order to represent codes that are not simple numbers.

The NAS1638 standard defines classes "00" and "000", these are classes "cleaner" than class 0. We represent these using signed integers of value -1 and -2 respectively (these will appear as 255 and 254 if read as unsigned integers).

#### 9.2.2.4.2 Message: Status

The message is transmitted every 1 second so that it can be used as a "heartbeat".

However if no test has been performed yet, the ICM 4.0 will wait until it sees other CANbus activity before sending anything.

Byte	Bit	Length	Type	Item
1-4	1	32	Unsigned	Test Number
5	1	8	Unsigned	Status Code
6	1	8	Unsigned	Completion
7-8	1	16	Bitmask	Status Flags

Test Number - The current Test Number is an auto-incremented integer or can also be set as part of the Test Start command. This is used to distinguish tests / circuits.

Status Code - This is a number used to indicate the current state of the ICM 4.0, or a fault code in the case of a problem being detected. The codes are listed in Table III. This allows a system to remotely monitor the ICM 4.0 operation, if desired, allowing more specific diagnostics.

# REFERENCE

Completion - A number between 0 and 100 indicating the progress of the test. This will increase from 0 to 100 during the set test time. It can be used to drive a progress indicator.

Status Flags - This is a group of flags indicating test status.

## 9.2.2.4.2.1 Status Flags Bitmask

This is identical to table 8D.

Bits 0-2 are so that external equipment (for example LPA-View or a PLC/MMI) can display, update and log results intelligently

Bits 3 and 4 can be used to monitor the test progress.

Bits 5-10 are used to generate alarms. Depending on the selected alarm mode, they operate the alarm relay output(s). But they can also be monitored directly by a PLC/MMI program and used to drive indicators, for example.

Bit 11 is used internally to detect that the ICM 4.0 is being controlled by Modbus (from a PLC or by LPA-View).

Finally bits 12-14 reflect the state of the ICM 4.0 “start signal” input and alarm output relays.

## 9.2.2.4.3 Message: Water Sensor

Byte	Bit	Length	Type	Item
1	1	8	Unsigned	RH%
2	1	8	Signed	Temperature degrees C

## 9.2.2.4.4 Message: Commands

Various commands can be sent to the ICM 4.0 via CANbus. For J1939 networks Peer-to-Peer (PDU1) Messages are used. For CanOpen networks Receive Process Data Objects are used.

Byte	Bit	Length	Type	Item
1	1	8	Unsigned	Command Byte (0x00)
2	1	8	enum	(0, 1, 2, ...)
3-6	1	32	Unsigned	Parameter

enum	Function	Parameter
1	Start Test	None
9	Stop Test	-
13	Start Test	Fixed Test Number
14	Format ISO 4406	Set ISO 4406 result format
15	Format NAS1638	Set NAS1638 result format
16	Format AS4059_E2	Set AS4059E Table 2 result format
17	Format AS4059_E1	Set AS4059E Table 1 result format
18	Format ISO11218	Set ISO11218 result format

### 9.3 Hydraulic System Target Cleanliness Levels

Where a hydraulic system user has been able to check cleanliness levels over a considerable period, the acceptability, or otherwise, of those levels can be verified.

Thus if no failures have occurred, the average level measured may well be one which could be made a bench mark. However, such a level may have to be modified if the conditions change, or if specific contaminant-sensitive components are added to the system. The demand for greater reliability may also necessitate an improved cleanliness level.

The level of acceptability depends on three features:

- The contamination sensitivity of the components
- The operational conditions of the system
- The required reliability and life expectancy

Contamination Codes ISO4409:1999			Corresponding Codes NAS1638	Recommended Filtration Degree	Typical Applications
4 $\mu$ m <sub>(c)</sub>	6 $\mu$ m <sub>(c)</sub>	14 $\mu$ m <sub>(c)</sub>	-	8x200	-
14	12	9	3	3	High precision and laboratory servo-systems
17	15	11	6	3-6	Robotic and servo-systems
18	16	13	7	10-12	Very sensitive high-reliability systems
20	18	14	9	12-15	Sensitive reliable systems
21	19	16	10	15-25	General equipment of limited reliability
23	21	18	12	25-40	Low pressure equipment not in continuous service



# REFERENCE

## 9.4 Clean Working Practices

The majority of hydraulic systems require cleanliness which controls below around a 40 micron threshold (beyond the limit of human eyesight). When analysing particles down to levels of 4µm, 6µm & 14µm you are talking about objects of a cellular/bacterial size. This creates various challenges, and is starting to drive better and cleaner working practices in industry. Our products are at the forefront of this challenge, and will help you to manage the quality and productivity of your systems.

### Do

- Do use filter breathers on tank tops
- Do use tank designs, which are self-draining (sloped or conical).
- Do use tanks which can be sealed off from the surrounding environment.
- Do exercise care and use funnels when filling tanks with fluid.
- Do utilize stainless steel and methods such as electro-polishing in the design of system components upstream of your first filter set.
- Do perform off-line analysis in a controlled environment such as a laboratory which should contain fewer airborne contaminants than where the sample was taken from.
- Do use suitable, glass bottles (ideally certified clean) to take samples, along with a hand pump to reduce contamination ingress.
- Do filter your system thoroughly before using it in your production process.
- Do perform a statistically large enough sample of particle analysis results (25) to arrive at a base cleanliness level for your system.
- Do make sure that filters are correctly sized for your applications and cleanliness you are trying to achieve.

### Don't

- Don't eat, drink or smoke around critical systems/processes.
- Don't leave tools, objects, clothing or other materials etc. on surfaces or tanks of critical systems.
- Don't use open tanks on critical systems.
- Don't take samples or perform on-line analysis from the top of a reservoir/tank.
- Don't design/use tanks which contain crevices (internal corners etc.).
- Don't assume that if a sample looks clean, that it is. You won't be able to see the contaminants.
- Don't perform off-line analysis in an "un-controlled" environment. E.g. workshop
- Don't rely on a single test for a capable representation of your system.
- Don't start using your system/process until it has gone through a commissioning period whereby contamination levels are relatively stable.
- Don't mix fluids into the same system. They can emulsify and eliminate any chance of a reliable particle count.
- Don't use unsuitable containers to take a fluid sample.



# SERVICE / RE-CALIBRATION

## 10 Service and Recalibration

Warranty	The ICM 4.0 is guaranteed for 12 months from date of receipt. See section 3 for further details.
Recalibration	The ICM 4.0 is recommended to be recalibrated every 12 months. Return to MP Filtri UK for recalibration.

# 11 Fault diagnosis and reporting

## 11.1 Diagnosing suspect ICM 4.0 readings

Most installation issues and service problems can be resolved quickly and easily by following the steps outlined in our online video installation guide. It can be found here:

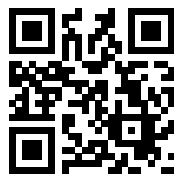

<https://youtu.be/wWf3NyWKQc> (Step 1)

If the video does not solve your problem, then please contact us - **you will need to supply us with your Product Part Number and Product Serial Number.**

# FAULT DIAGNOSIS AND REPORTING

To enable us to offer a fast, responsive service, it will be helpful if you can supply the following information:

Product Part number ICM 4.0:

Product Serial number:

<b>Application</b>	Powerpack, Filter Trolley, System Application, other
<b>Industry</b>	Aerospace, Mobile, Industrial, Marine, Oil and Gas, Automotive, other
<b>Installation</b>	Permanently Installed, Mobile, other
<b>Fluid type</b>	Mineral, Synthetic, Bio-degradable, Subsea Fluid, Water, Diesel, other. Please name and supply material data information for compatibility with internal seals and wetted internal parts
<b>Viscosity</b>	0-1000 cSt
<b>System Pressure</b>	bar/PSI - Min/Max. Variable pressure / Static pressure
<b>How is ICM 4.0 installed?</b>	Pressure line back to reservoir, Pressure line back to system, Return line back to reservoir, other
<b>Known differential pressure between ICM 4.0 inlet and ICM 4.0 outlet</b>	
<b>Connection type</b>	Minimess M16 X 2, Microbore hose, ¼ inch fittings, ¼ inch hose, other
<b>Length of Fitted Hoses</b>	Inlet / Outlet
<b>Pressure inlet to ICM 4.0</b>	bar / PSI
<b>Pressure outlet from ICM 4.0</b>	bar / PSI
<b>Any check valves / Flow control valves / Needle valves fitted</b>	
<b>Check Valve values</b>	bar/Pressure
<b>Indicated flow through ICM 4.0</b>	
<b>Volume of oil in application</b>	Litres /Gallons
<b>Pump flow</b>	Lpm /Gallons per minute
<b>Type of filtration installed</b>	Pressure, Return, Offline, other. If offline what is the pump flow rate of filter unit - 5 lpm, 10 lpm, 20 lpm, other
<b>Filtration micron rating</b>	3 micron, 6 micron, 10 micron, other
<b>Flow through filter during system operation</b>	Lpm /Gallons per min
<b>System operation per day</b>	8 hours, 16 hours, 24 hours, other
<b>Intended cleanliness range</b>	
<b>Actual cleanliness range</b>	
<b>Ambient temperature range</b>	
<b>System Temperature range</b>	
<b>Moisture content if applicable</b>	0-100 %
<b>Reason for suspecting errors /fault</b>	Why do you think the ICM 4.0 is not reading correctly
<b>Has a Laboratory analysis been carried out?</b>	If yes please supply results and report
<b>Pictures of ICM 4.0 screens</b>	Screen 1 - ISO /NAS Screen; Screen 2 -Last 10 readings; Screen 3 - Particle count distribution
<b>Download and send all particle counts from LPA-view</b>	
<b>Pictures of application</b>	
<b>Any Faults showing on ICM 4.0 screen</b>	e.g Optical fault, High Flow, Low flow, No readings (-/-/-)
<b>Optical fault What is LED value</b>	What is LED value
<b>Notes and Comments</b>	

The data and information contained in this publication are provided only for the purpose of information.  
MP Filtri reserves the right to make changes to the models and versions of the products described at any time,  
both for technical and commercial reasons.

The colours and photographs of the products are purely indicative.  
Any reproduction, partial or total, of this document is strictly prohibited.  
Rights reserved.





## WORLDWIDE NETWORK

### HEADQUARTERS

**MP Filtri S.p.A.**  
Pessano con Bornago  
Milano  
Italy  
[sales@mpfiltri.com](mailto:sales@mpfiltri.com)

### BRANCH OFFICES

**ITALFILTRI LLC**  
Moscow  
Russia  
[mpfiltrirussia@yahoo.com](mailto:mpfiltrirussia@yahoo.com)

**MP Filtri Canada Inc.**  
Concord, Ontario  
Canada  
[sales@mpfiltricanada.com](mailto:sales@mpfiltricanada.com)

**MP Filtri France SAS**  
Lyon  
AURA  
France  
[sales@mpfiltrifrance.com](mailto:sales@mpfiltrifrance.com)

**MP Filtri Germany GmbH**  
St. Ingbert  
Germany  
[sales@mpfiltri.de](mailto:sales@mpfiltri.de)

**MP Filtri India Pvt. Ltd.**  
Bangalore  
India  
[sales@mpfiltri.co.in](mailto:sales@mpfiltri.co.in)

**MP Filtri (Shanghai) Co., Ltd.**  
Shanghai  
P.R. China  
[sales@mpfiltrishanghai.com](mailto:sales@mpfiltrishanghai.com)

**MP Filtri U.K. Ltd.**  
Bourton on the Water  
Gloucestershire  
United Kingdom  
[sales@mpfiltri.co.uk](mailto:sales@mpfiltri.co.uk)

**MP Filtri U.S.A. Inc.**  
Quakertown, PA  
U.S.A.  
[sales@mpfiltriusa.com](mailto:sales@mpfiltriusa.com)

**PASSION TO PERFORM**



[mpfiltri.com](http://mpfiltri.com)